

BB SHEET NAME	REF AREA
<i>top level (2av)</i>	1000-1100
<i>cellular/cmt_if/camera</i>	1500-1999
<i>cellular/cmt_if/conn/sys_conn</i>	2000-2059
<i>cellular/cmt_if/conn/prod_test_pattern</i>	2060-2069
<i>cellular/cmt_if/conn/battery_conn</i>	2070-2099
<i>cellular/cmt_if/audio</i>	2100-2199
<i>cellular/cmt_engine/power/vilma</i>	2200-2299
<i>cellular/cmt_engine/power/betty</i>	2300-2389
<i>cellular/cmt_engine/power/coreps</i>	2390-2399
<i>cellular/cmt_if/ui</i>	2500-2599

BB SHEET NAME	REF AREA
<i>cellular/cmt_if/ui/display</i>	2400-2449
<i>cellular/cmt_if/ui/keyboard</i>	2450-2499
<i>cellular/cmt_if/irda</i>	2600-2699
<i>cellular/cmt_if/sim (not in use)</i>	2700-2799
<i>cellular/cmt_engine/digi/rap</i>	2800-2849
<i>cellular/cmt_engine/digi/usb_conn</i>	2845-2849
<i>cellular/cmt_engine/digi/genio_mux</i>	2850-2899
<i>cellular/cmt_engine/digi/mem_cmt</i>	3000-3099
<i>cellular/cmt_if/emu_rap</i>	3100-3199
<i>cellular/cmt_if/mmc (not in use)</i>	3200-3299

BB SHEET NAME	REF AREA
<i>cellular/cmt_if/hs_usb</i>	3300-3999
<i>cellular/cmt_if/bt</i>	6000-6099
<i>cellular/cmt_if/fm</i>	6100-6199
<i>cellular/cmt_if/wlan</i>	6300-6399

RF SHEET NAME	REF AREA
RF	7500-7699
RF External (DIY)	7400-7499

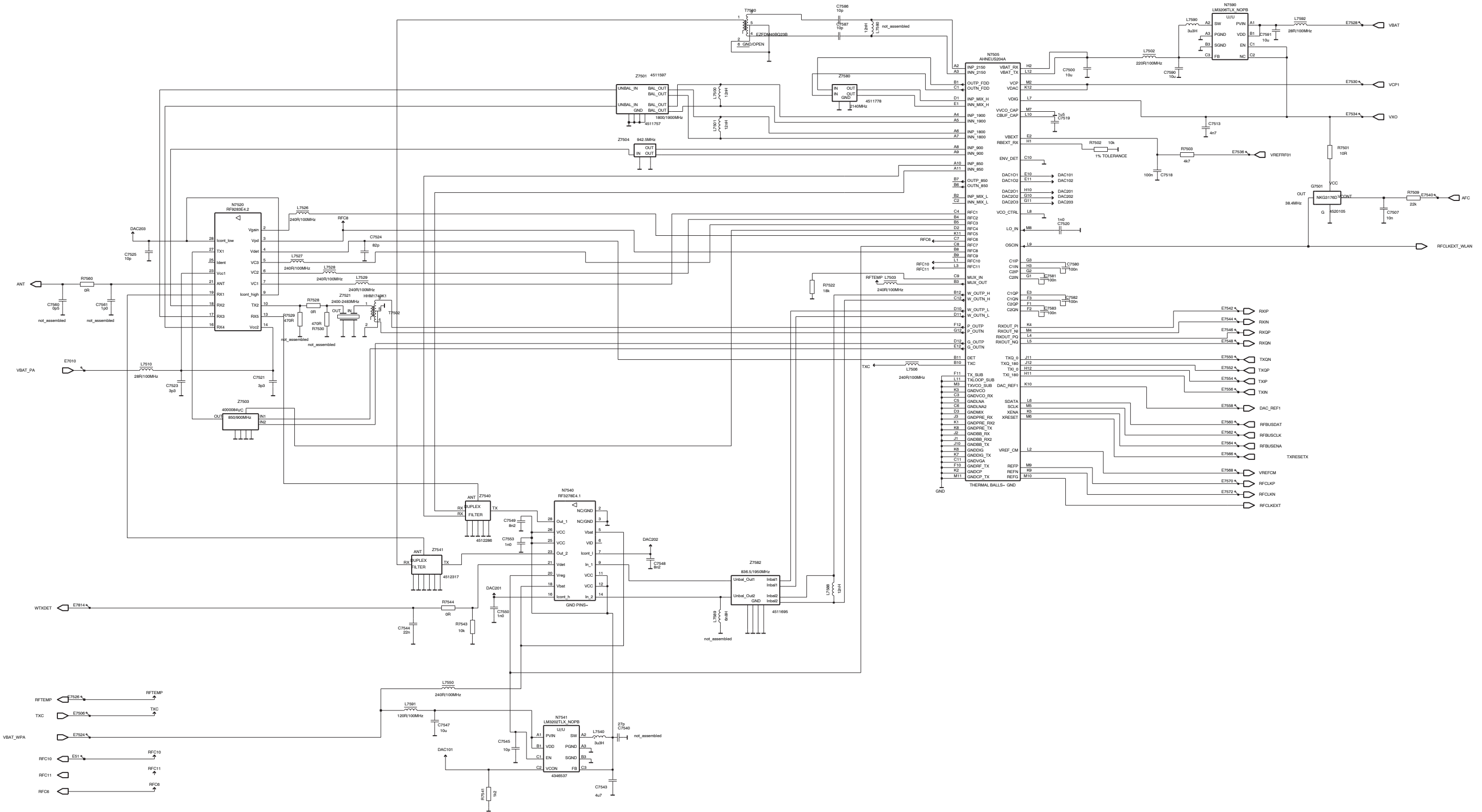

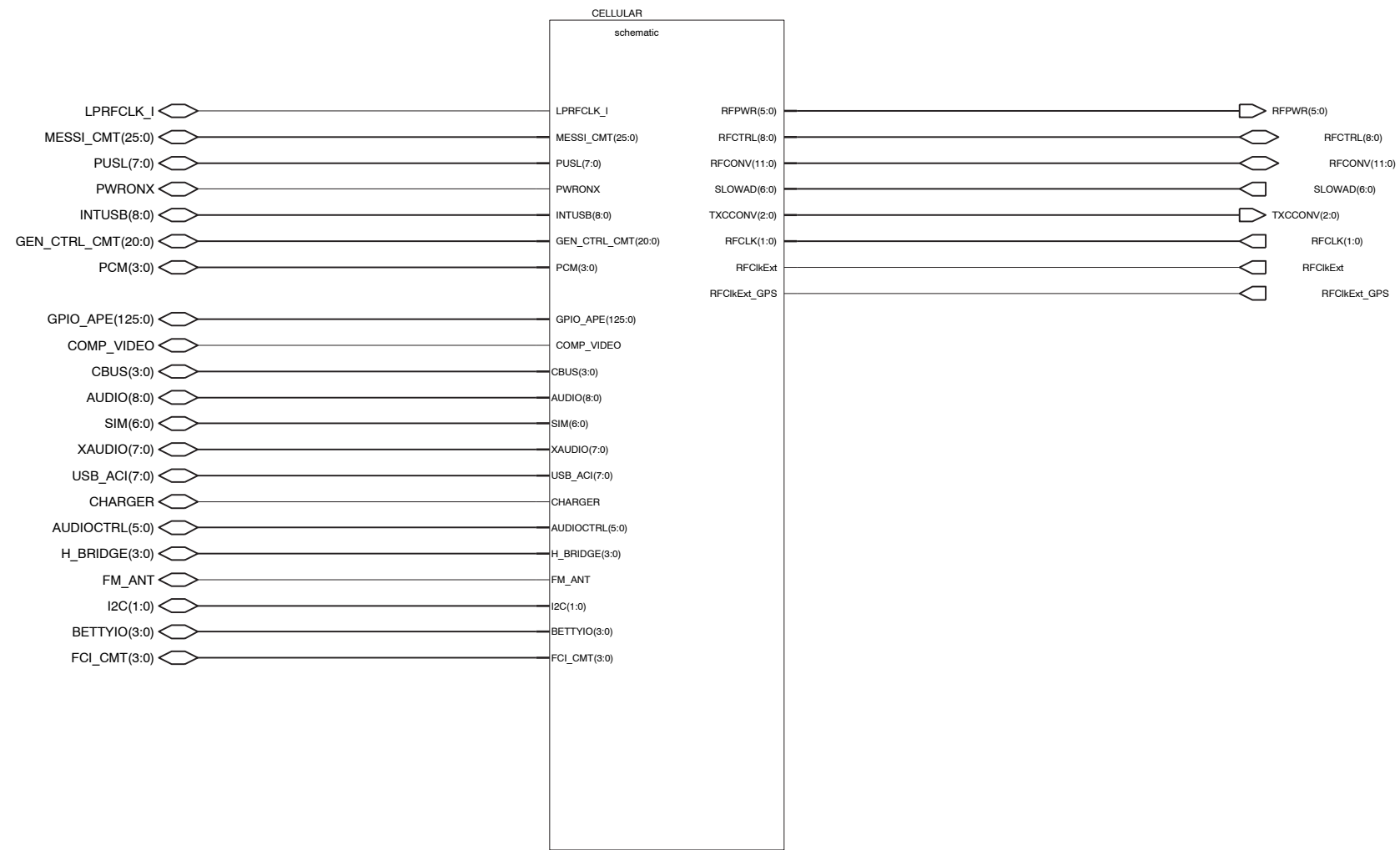

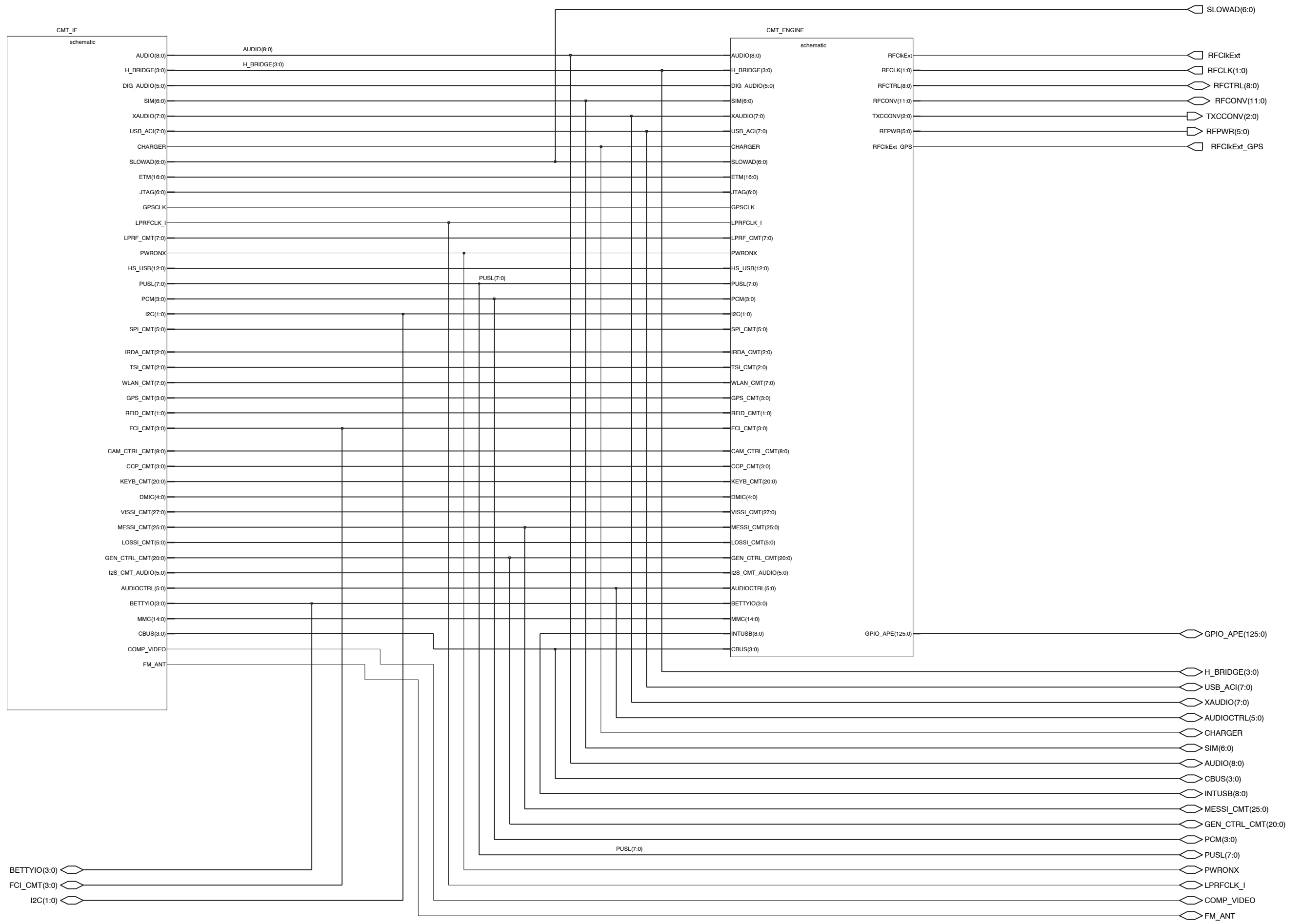

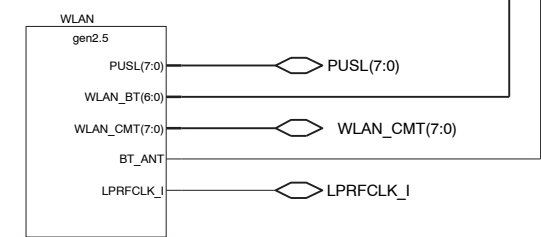
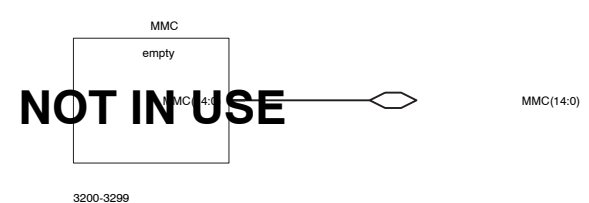
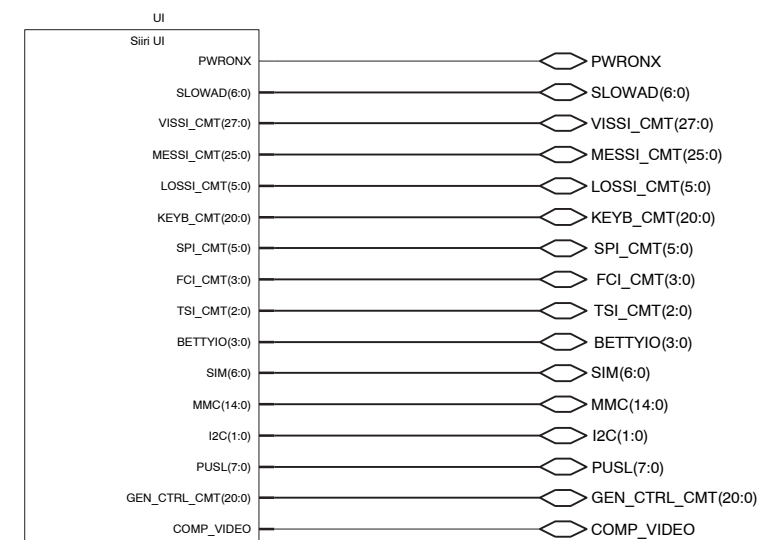
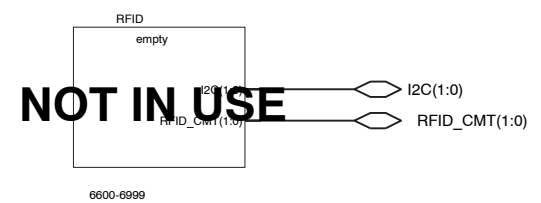
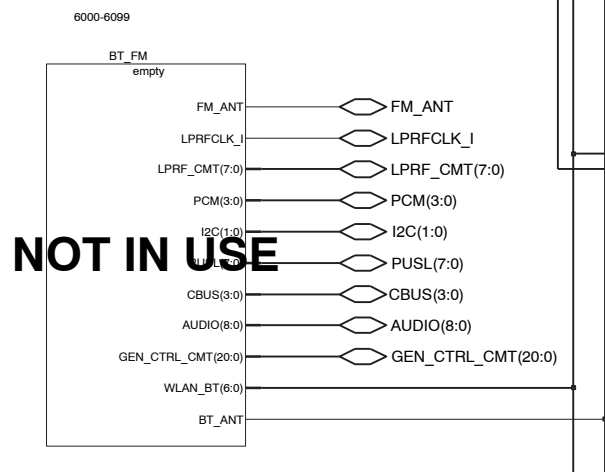
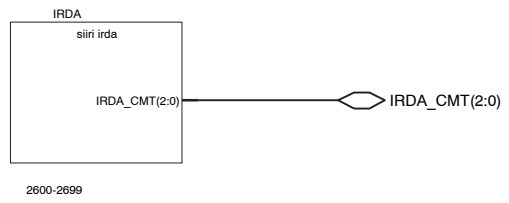
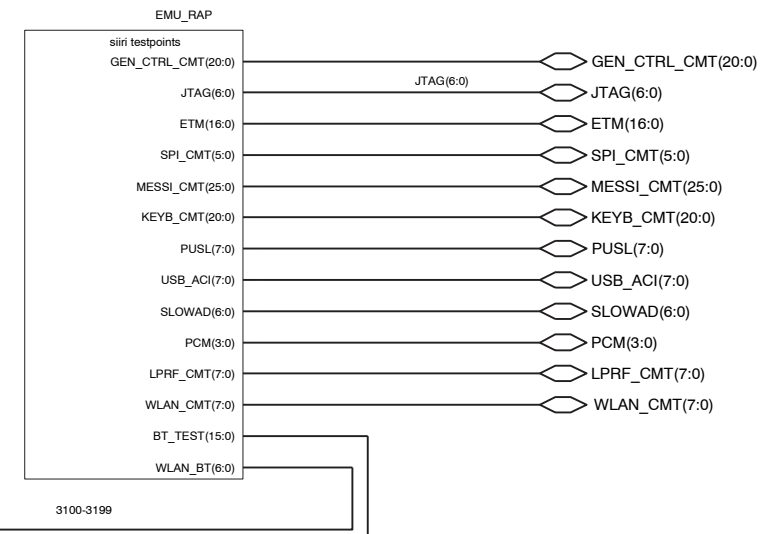
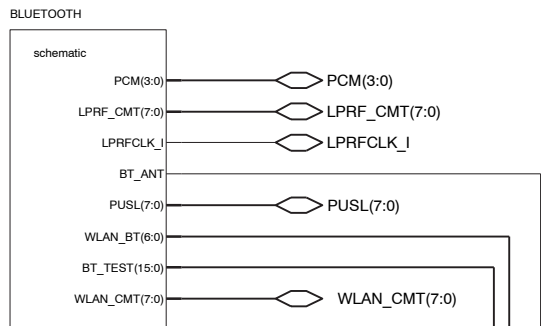
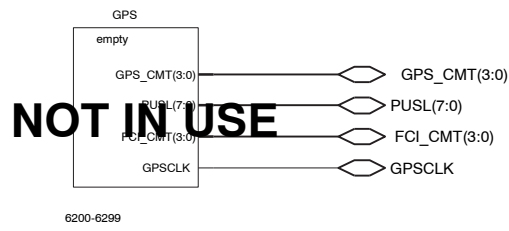
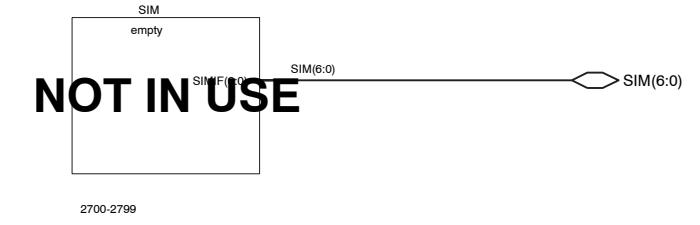
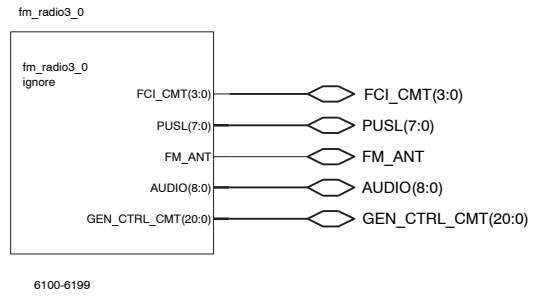
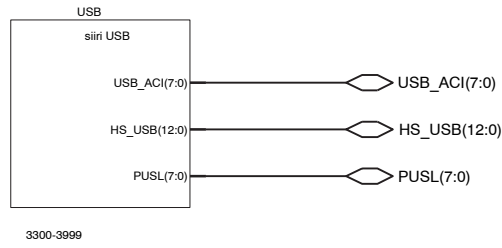
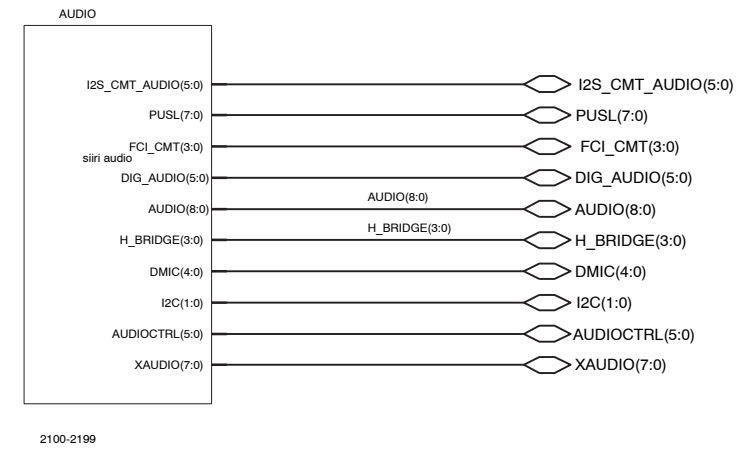
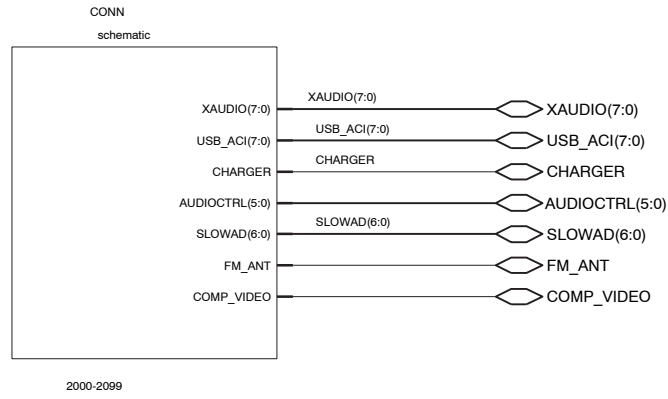
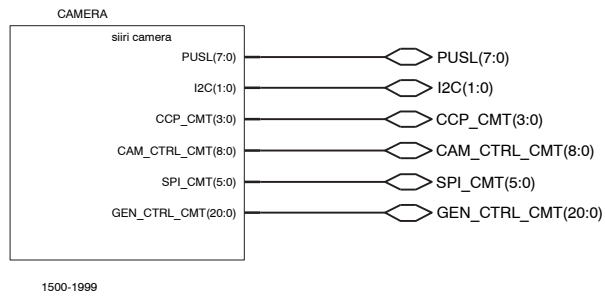

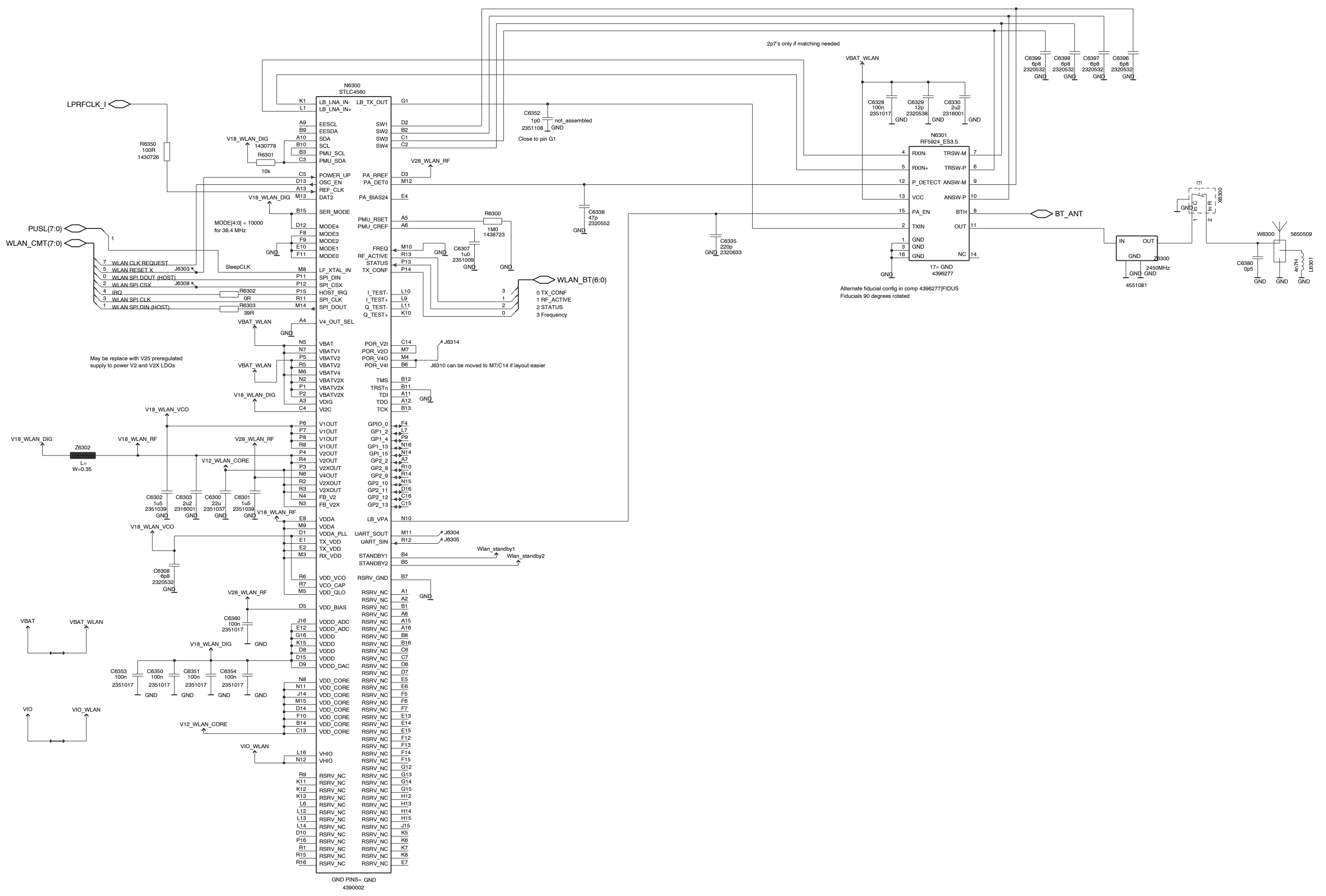

GND PINS= GND
4390002

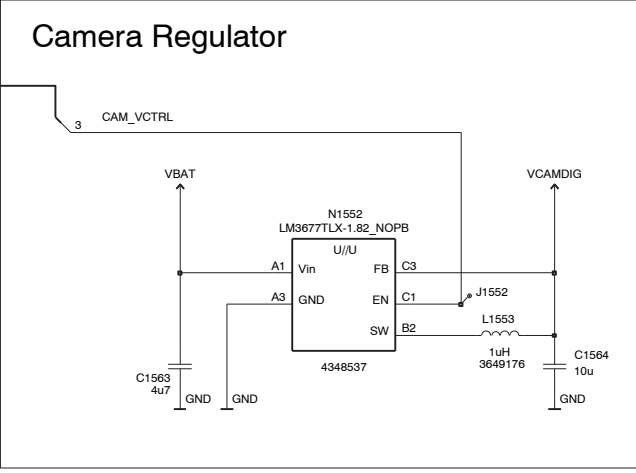
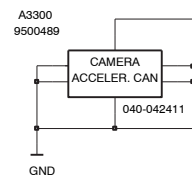
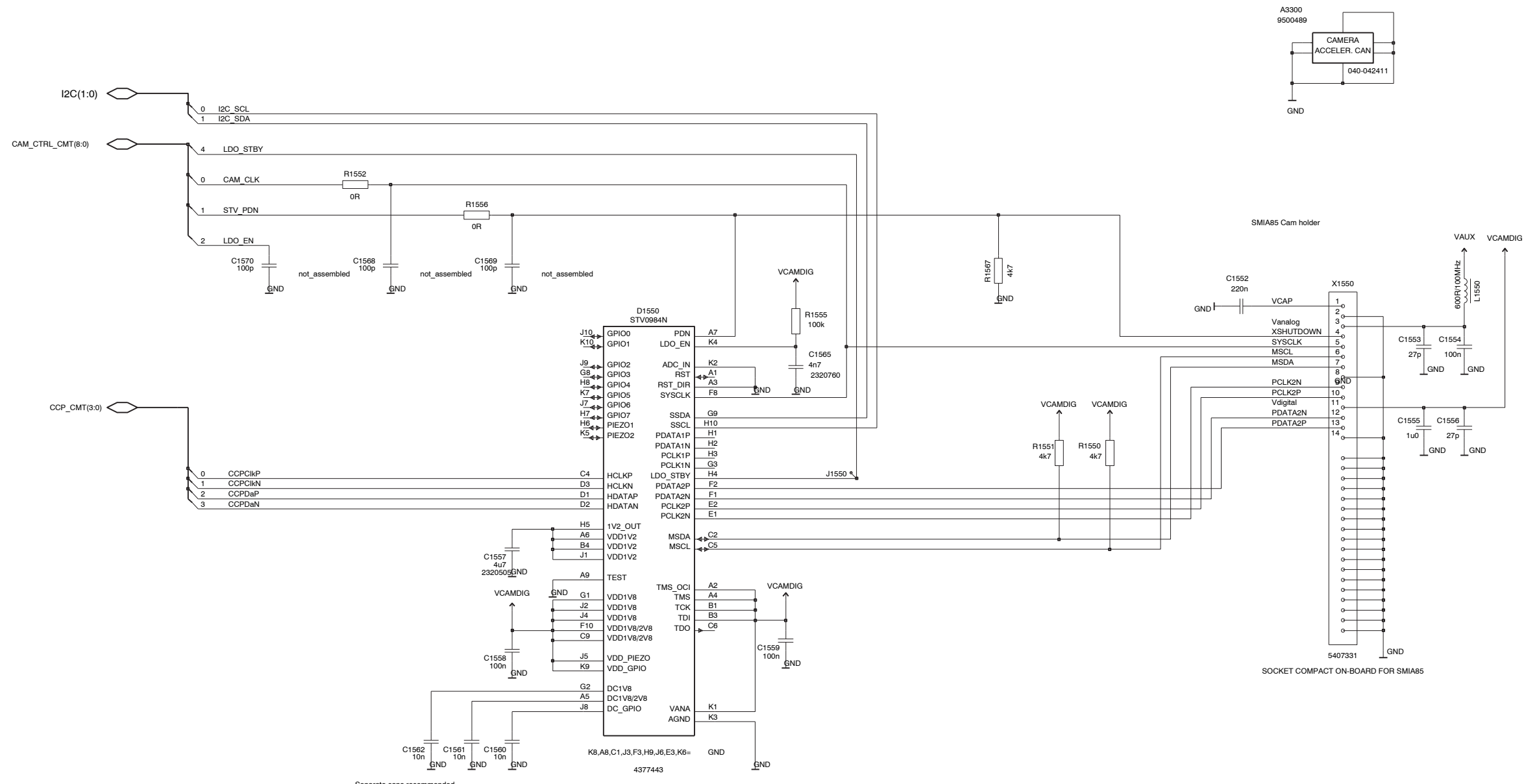

Separate caps recommended

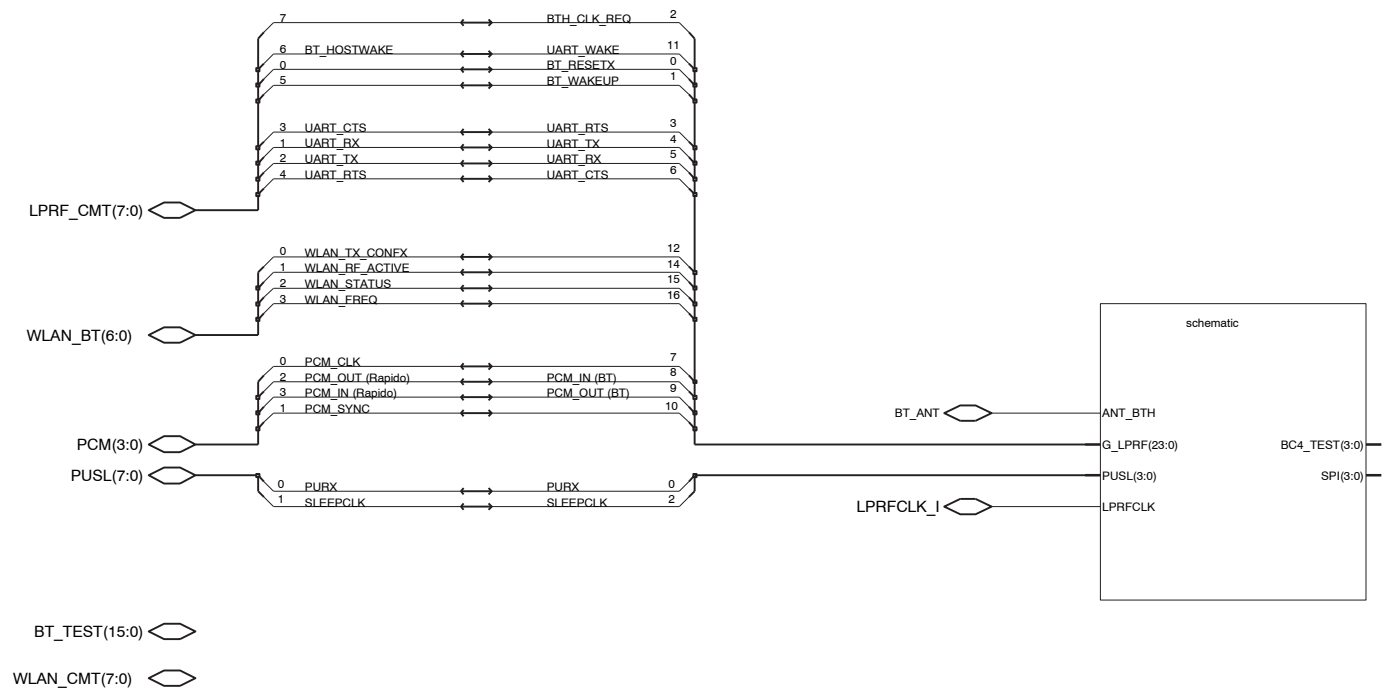

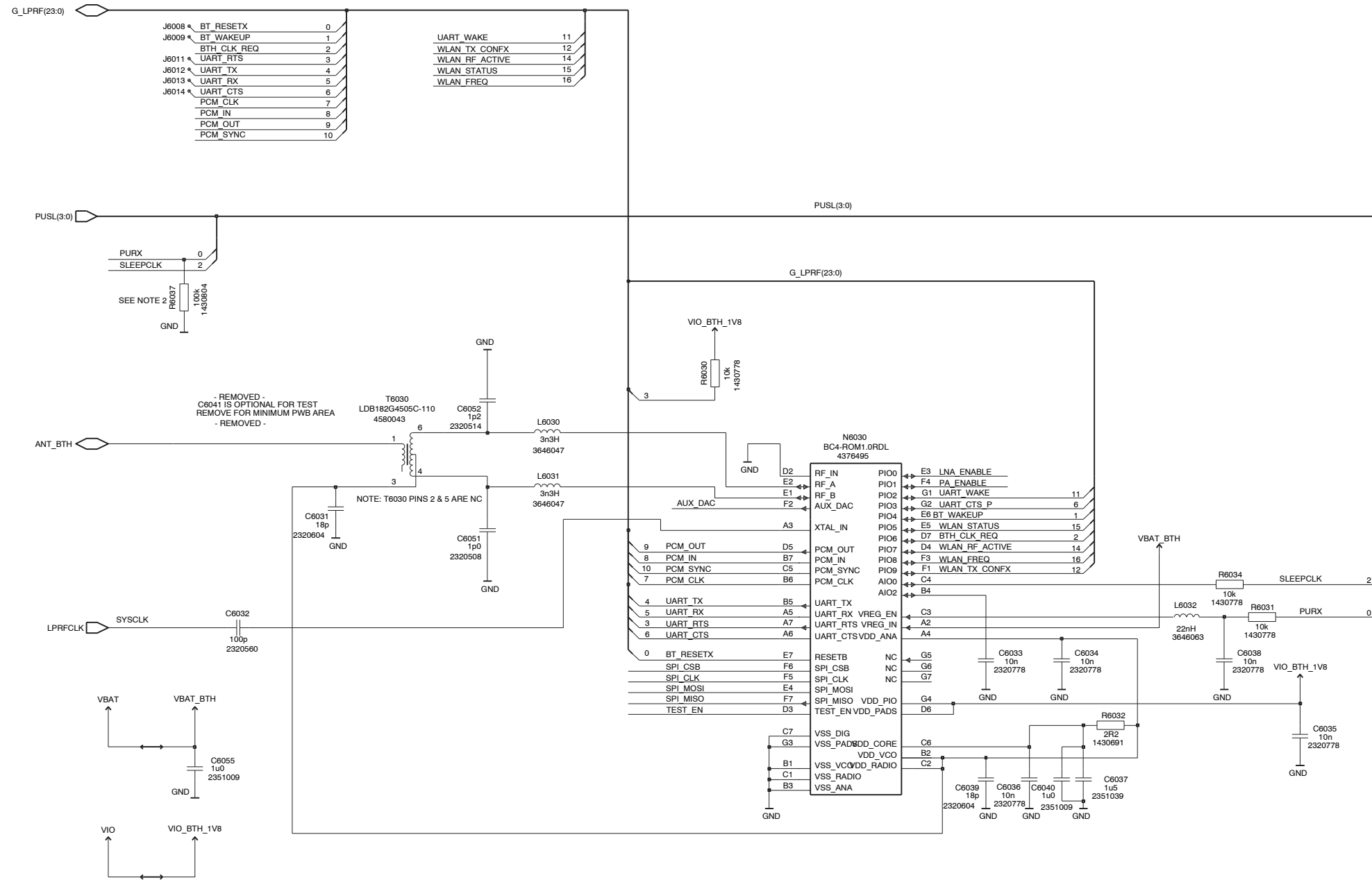

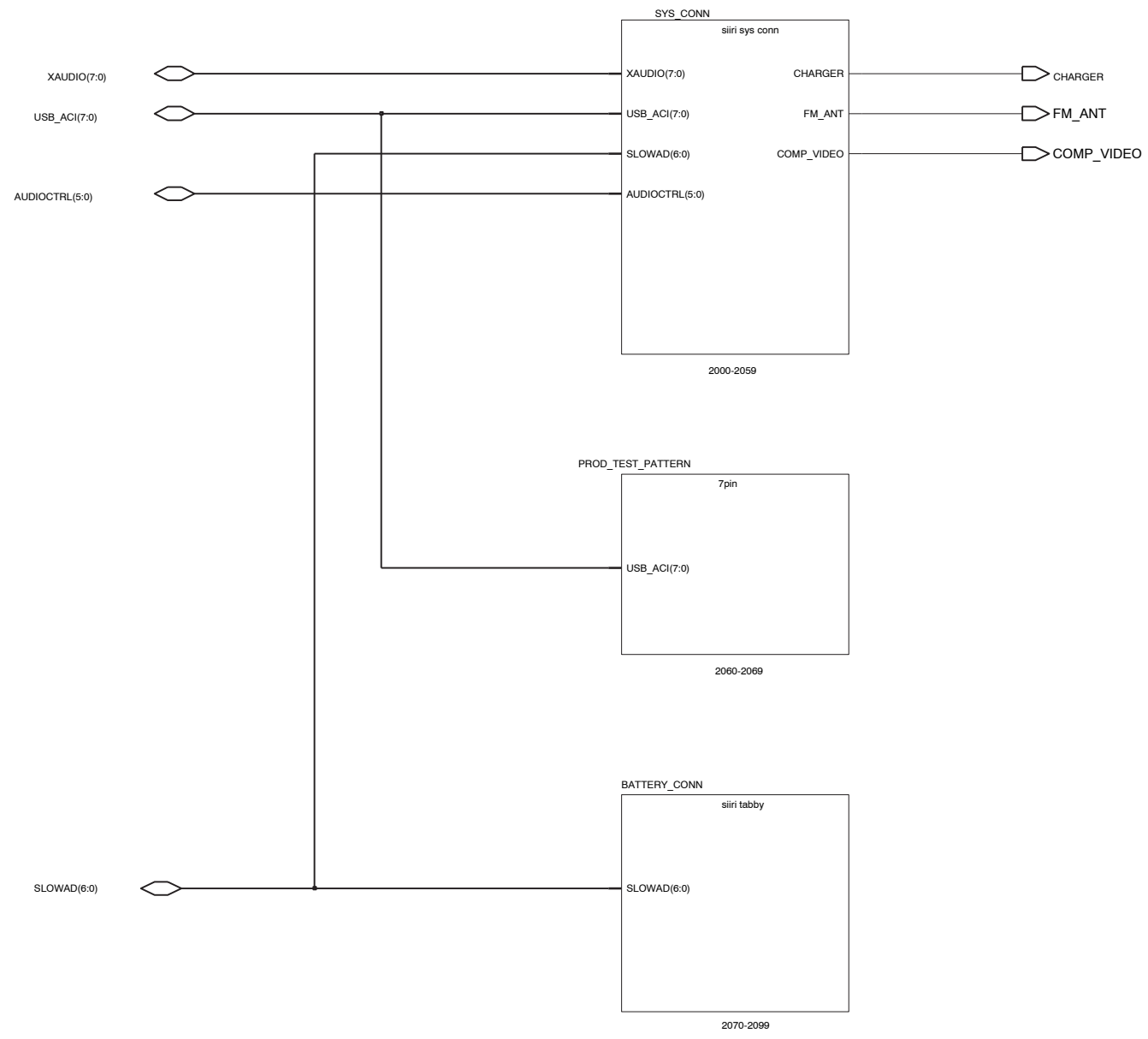

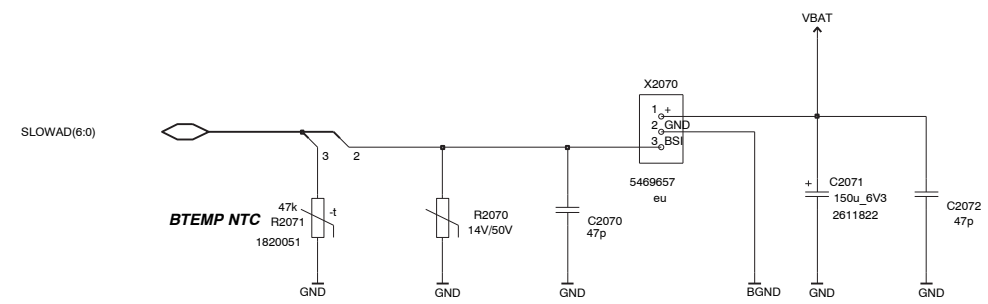

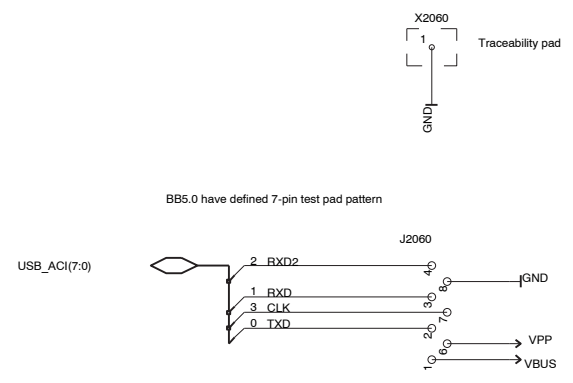

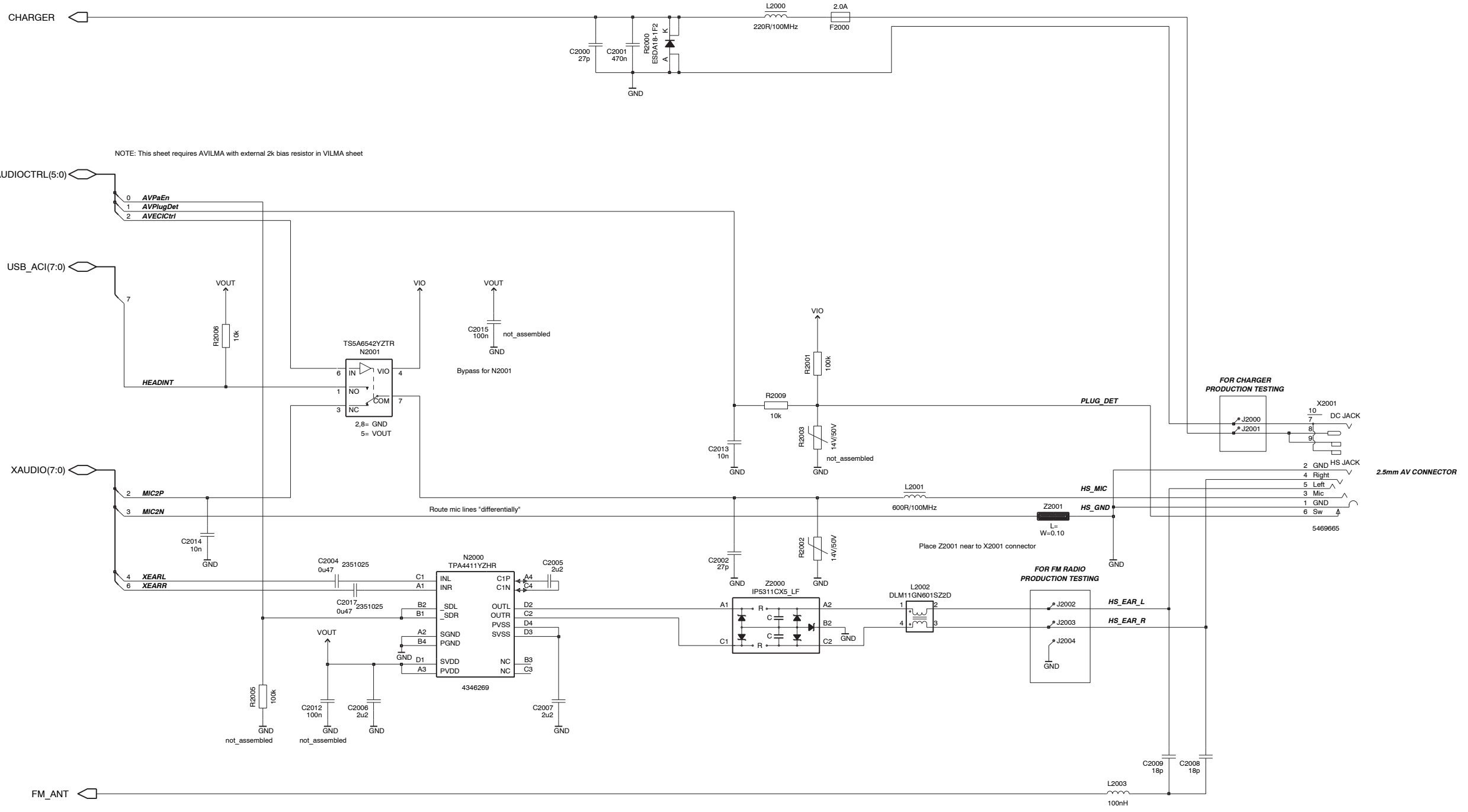

NOTE: This sheet requires AVILMA with external 2k bias resistor in VILMA sheet

FOR CHARGER PRODUCTION TESTING

FOR FM RADIO PRODUCTION TESTING

2.5mm AV CONNECTOR

Route mic lines "differentially"

Place Z2001 near to X2001 connector

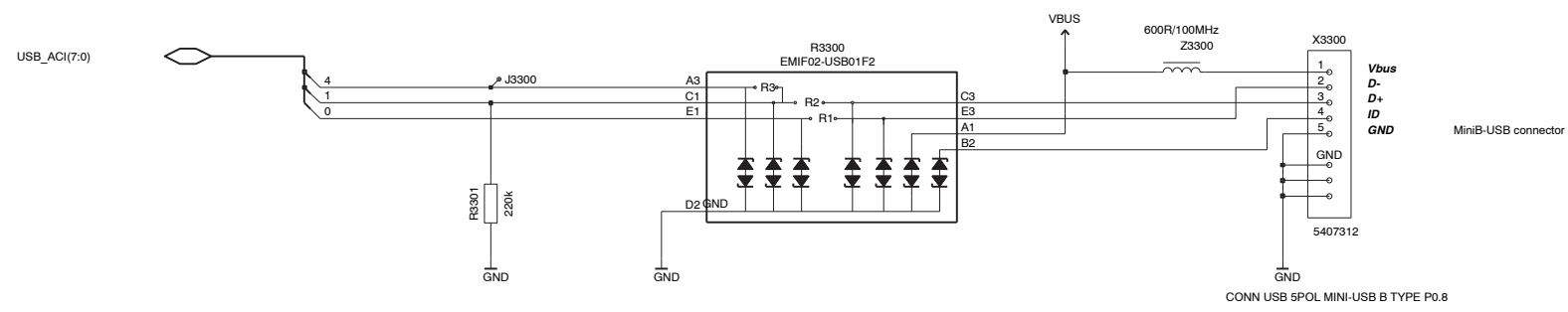

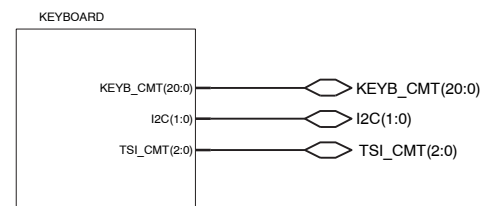
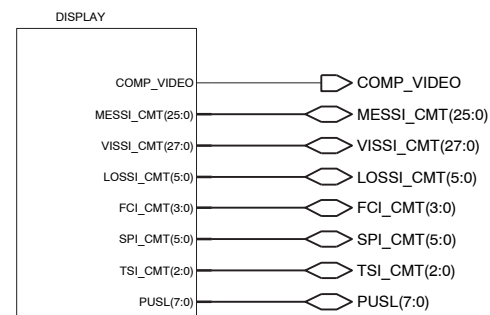
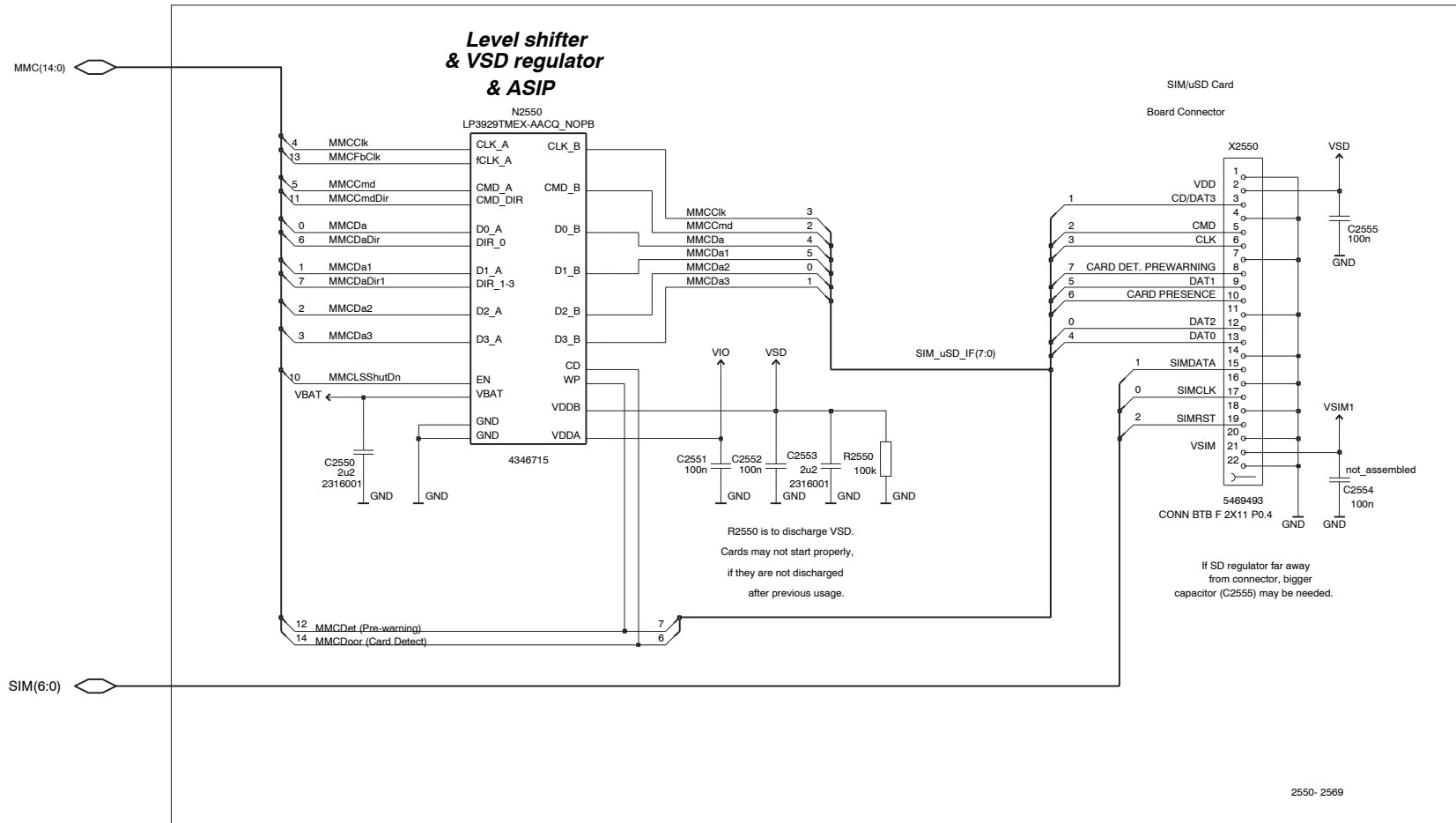
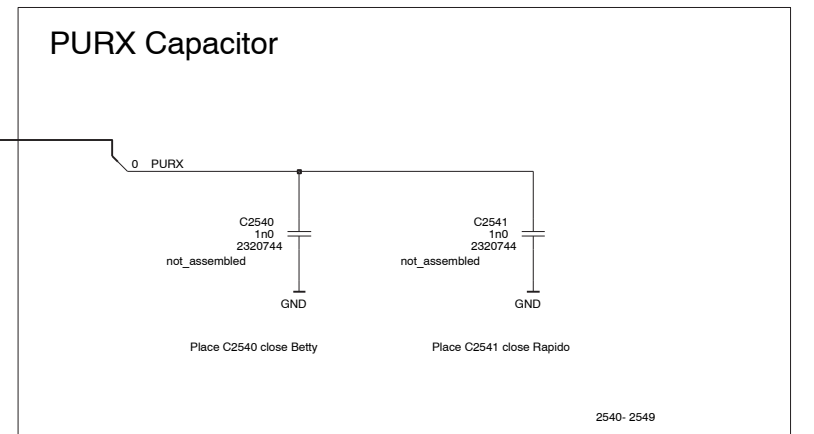
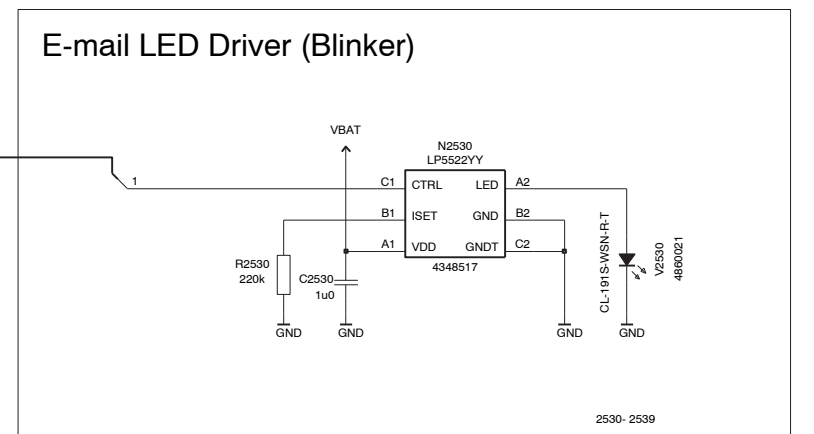
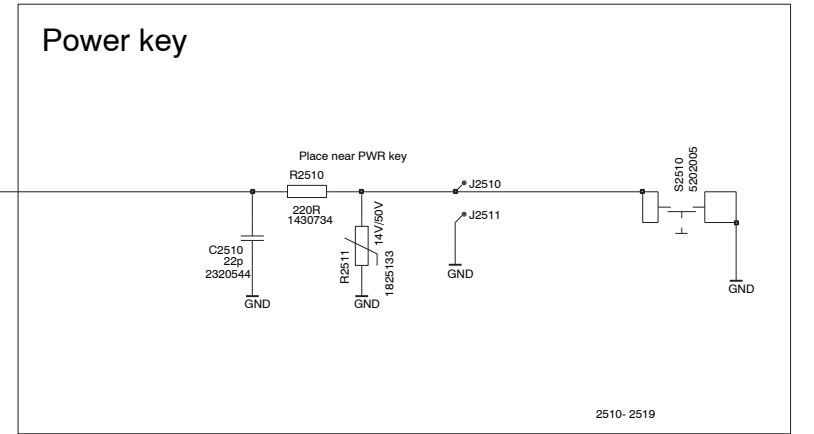
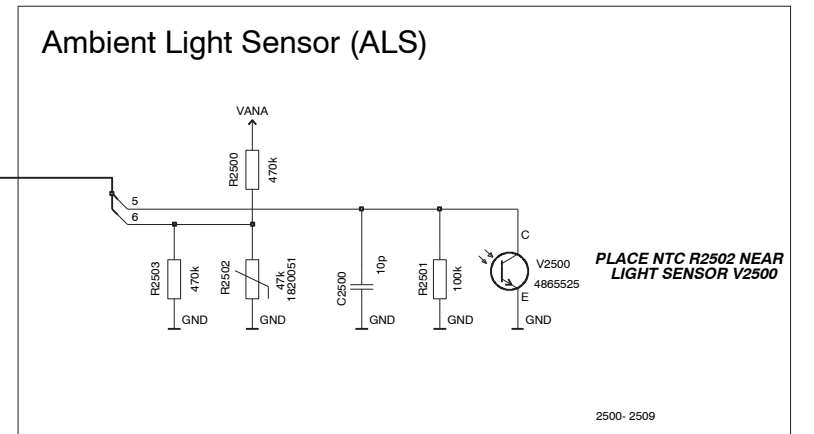

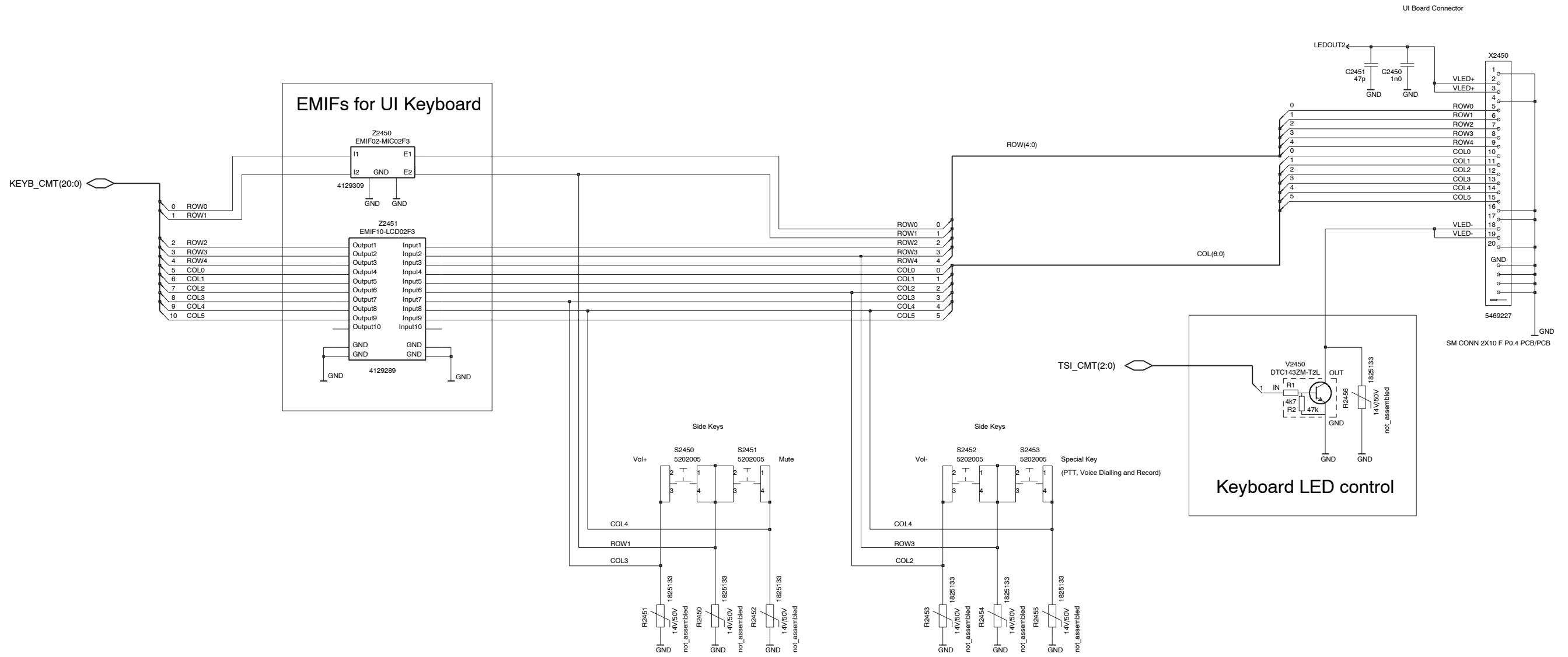

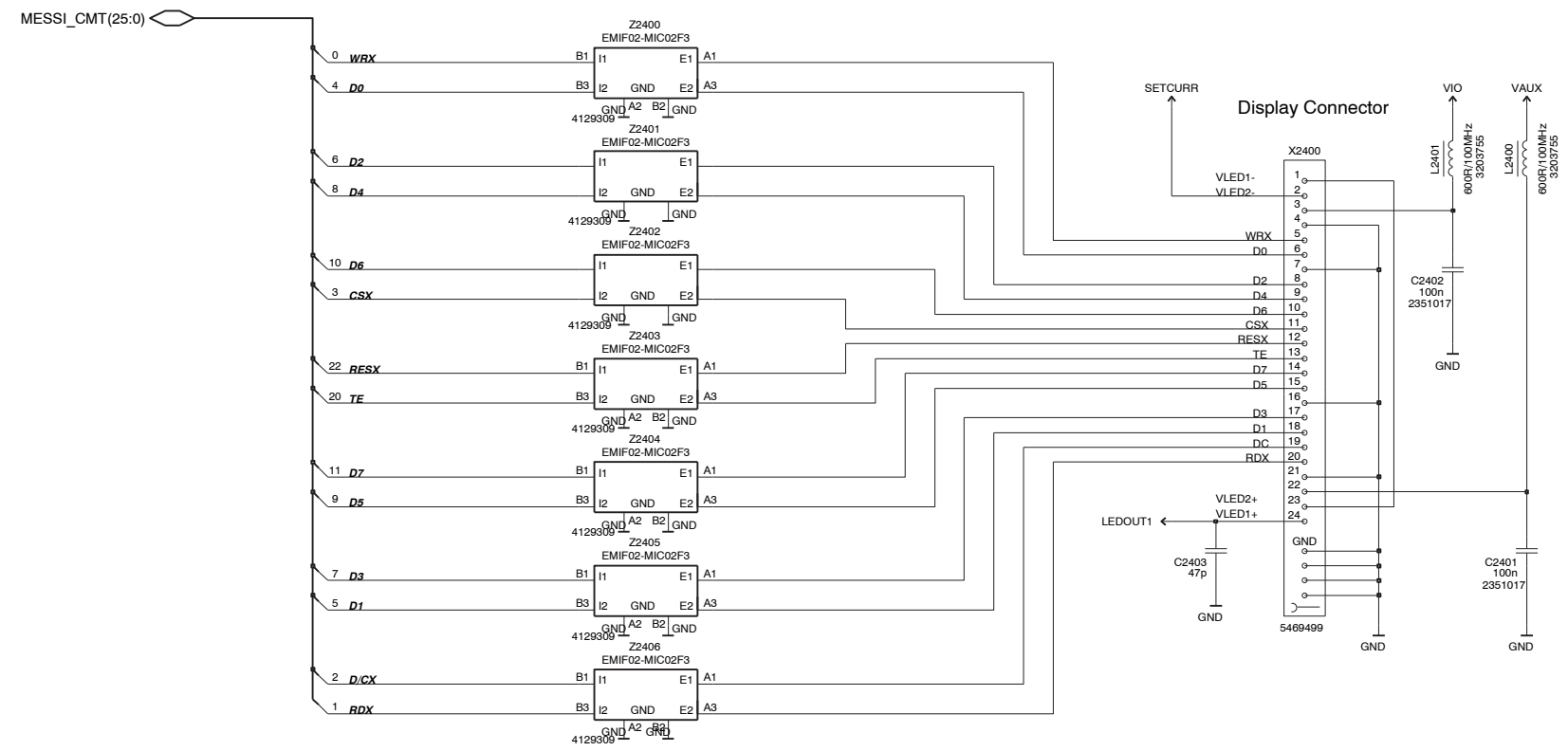

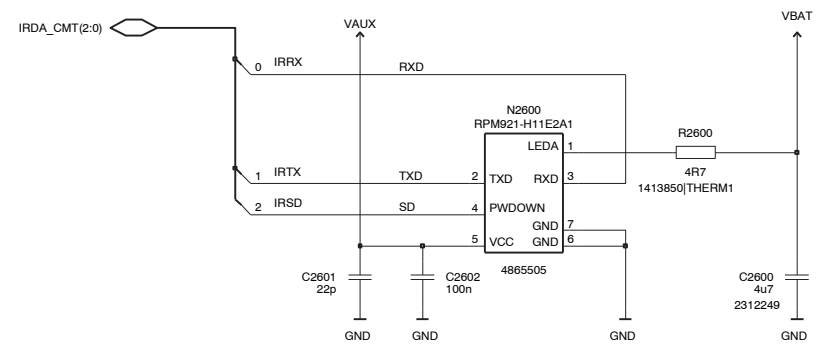

IRDA

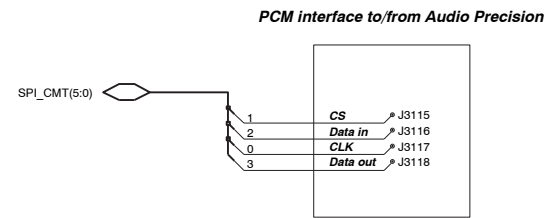
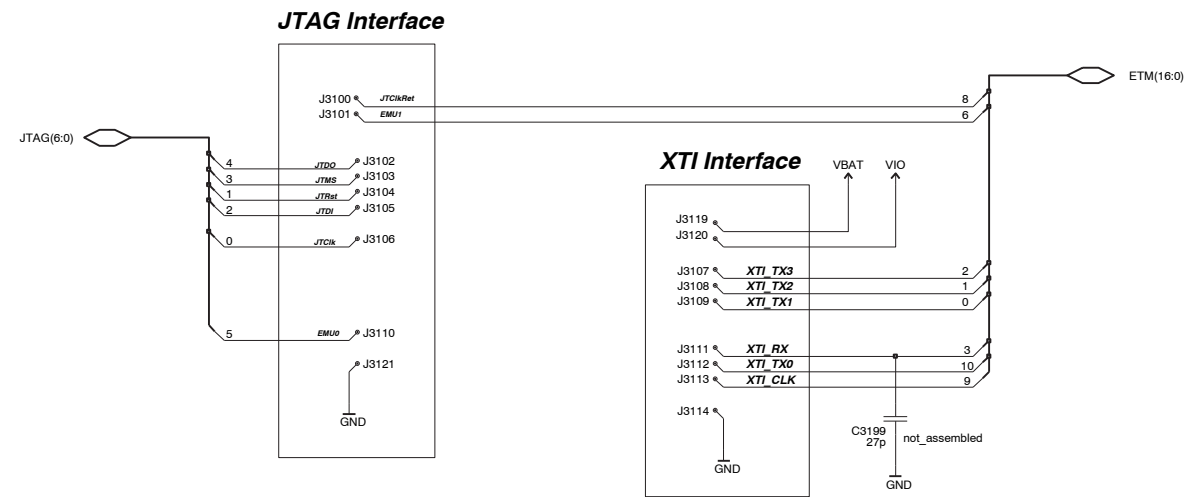

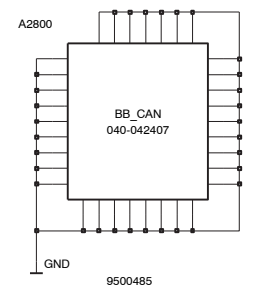
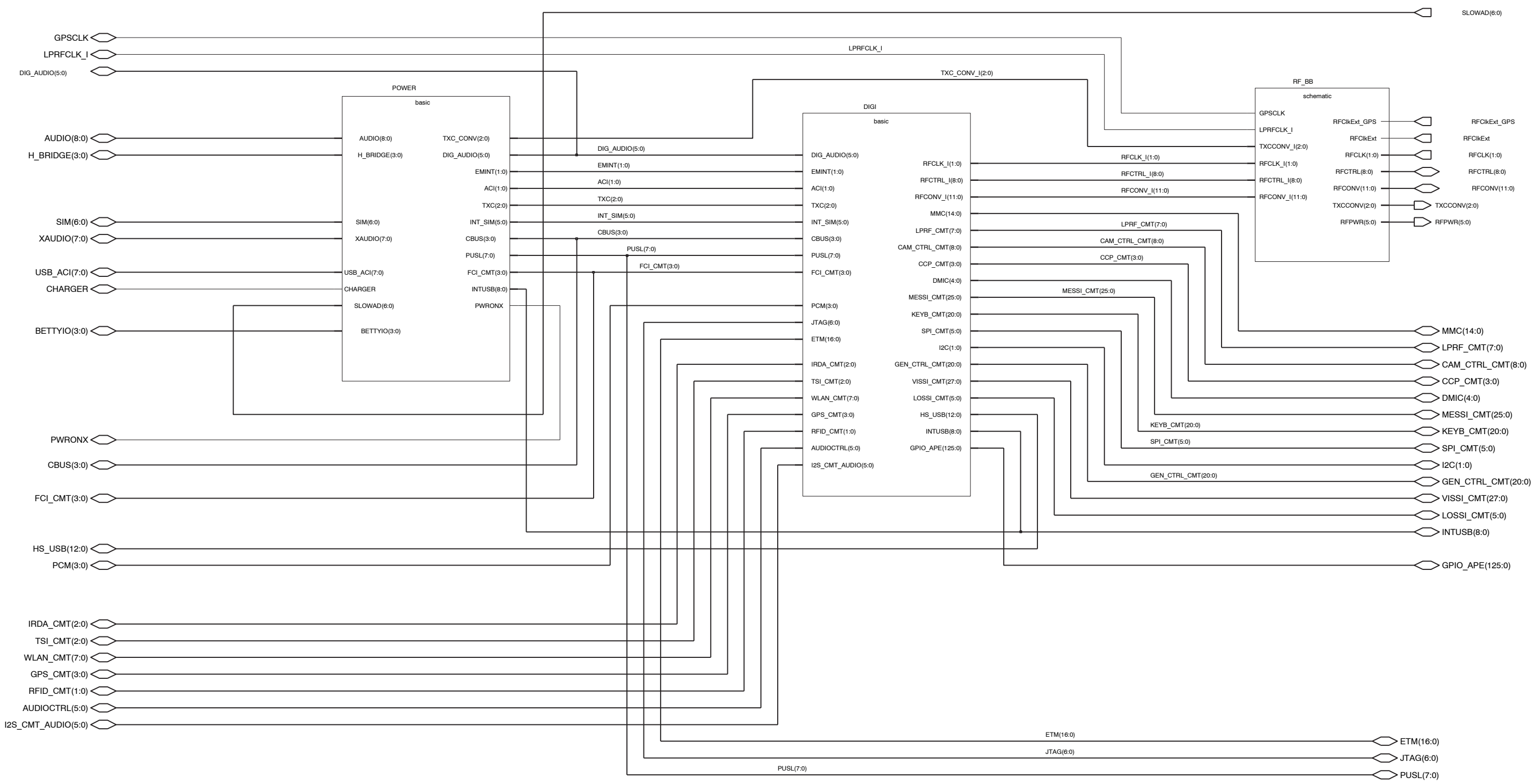

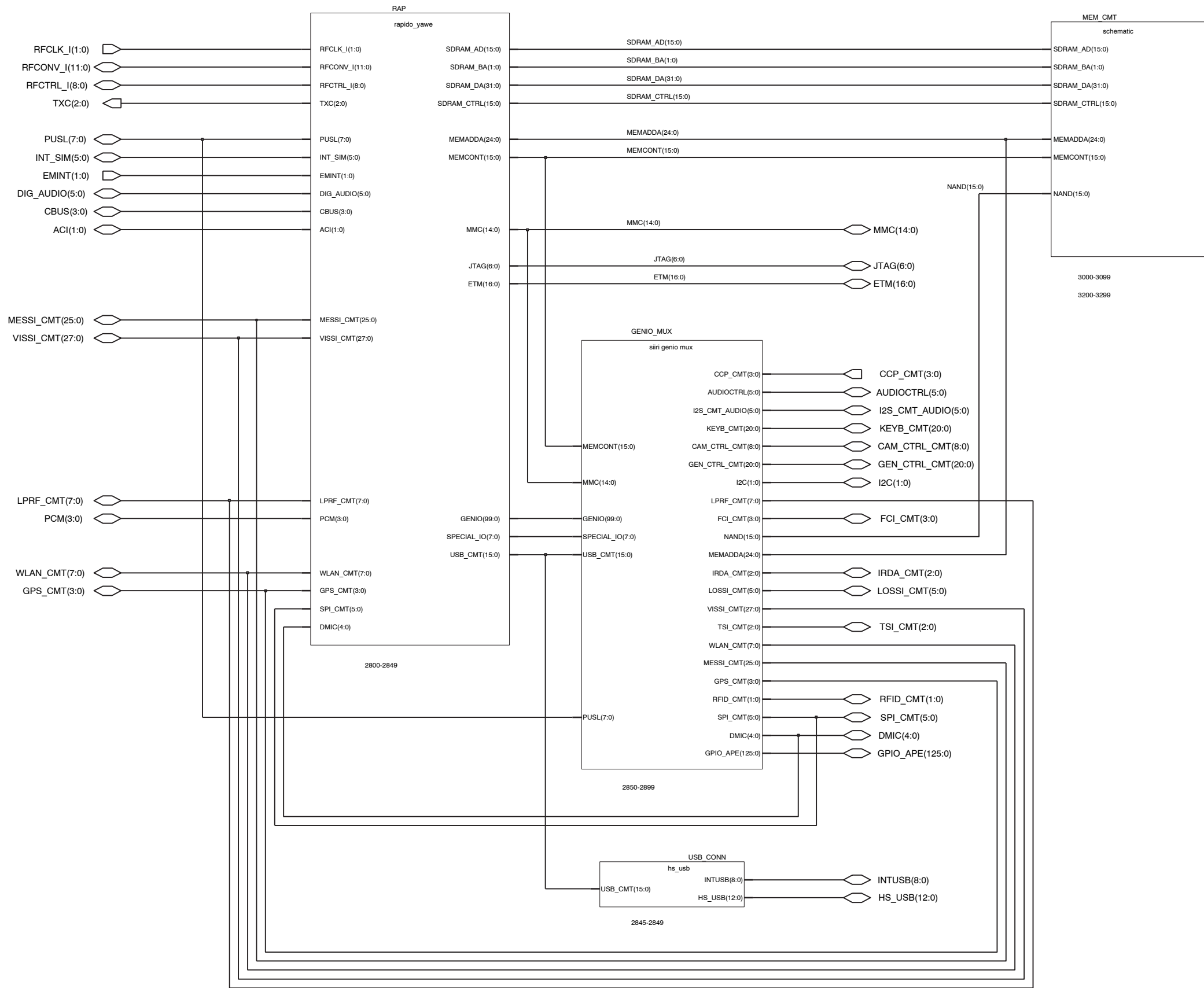

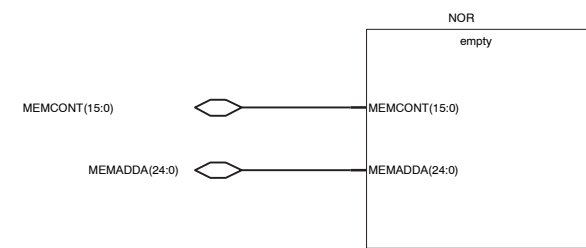
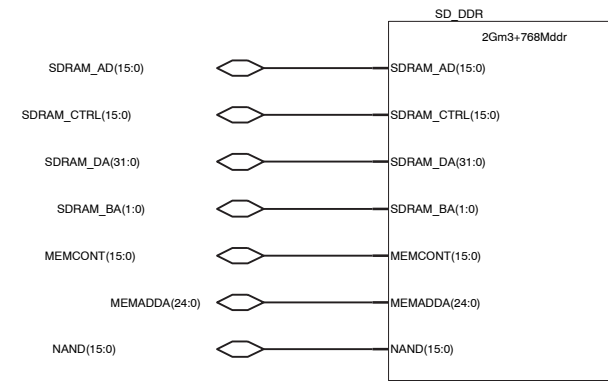

NOT IN USE

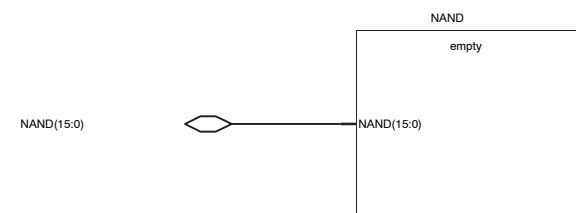

NOT IN USE

768Mb (DDR) + 2Gb (M3)

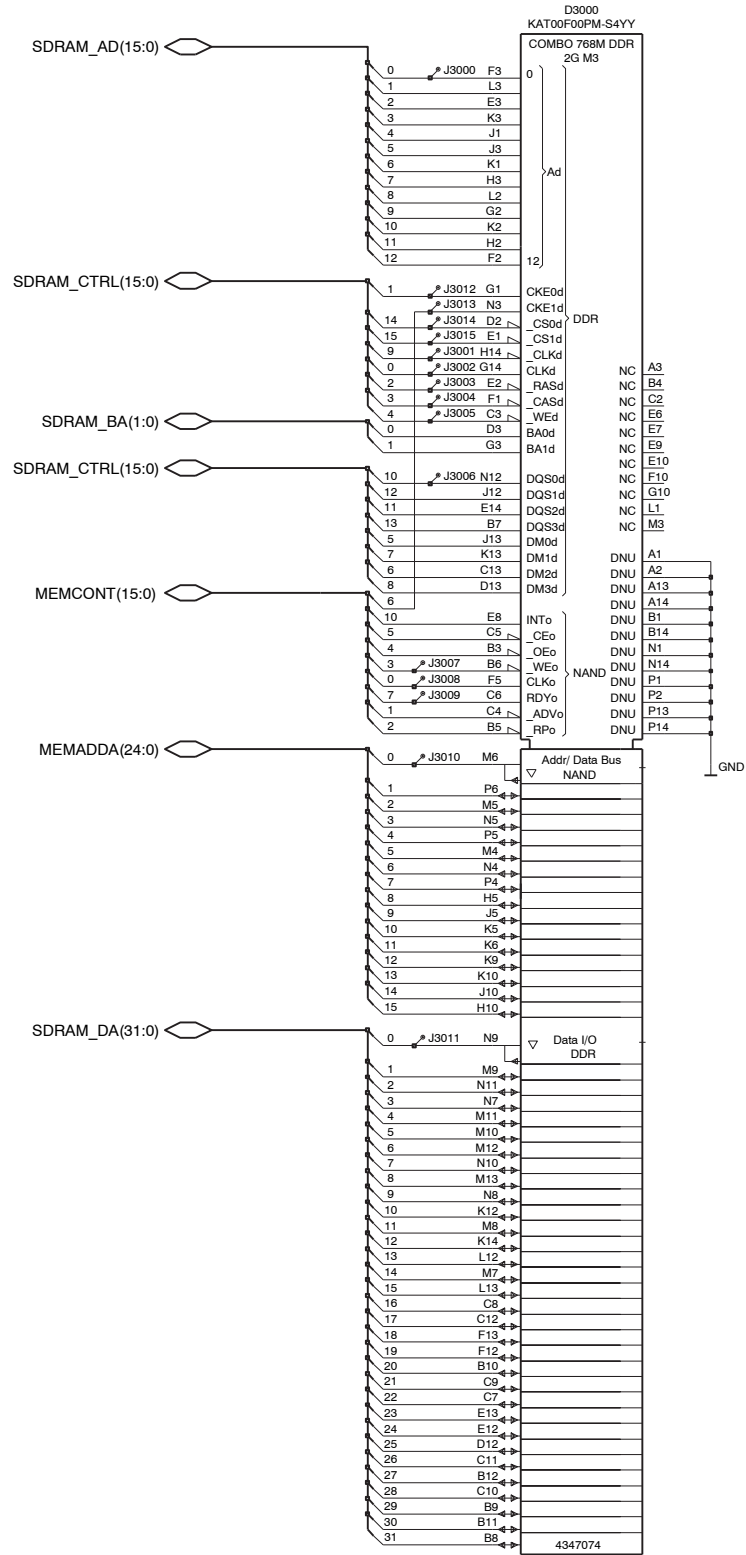
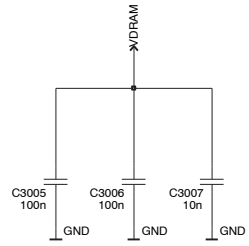
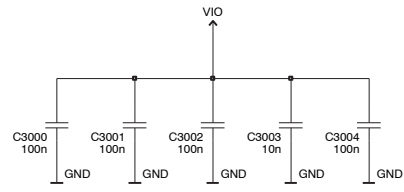

A11,D1,G12,H1,M2,P11= VDRAM
A7,A8,B13,C14,G13,H13,M14,N13,P7,P8= VIO
A5,E5= VIO
K7,N2= VIO
A6,A9,A12,D14,F14,J14,L14,N6,P9,P12= GND
A10,C1,H12,J2,M1,P10= GND
A4,B2,G5,K8,P3= GND

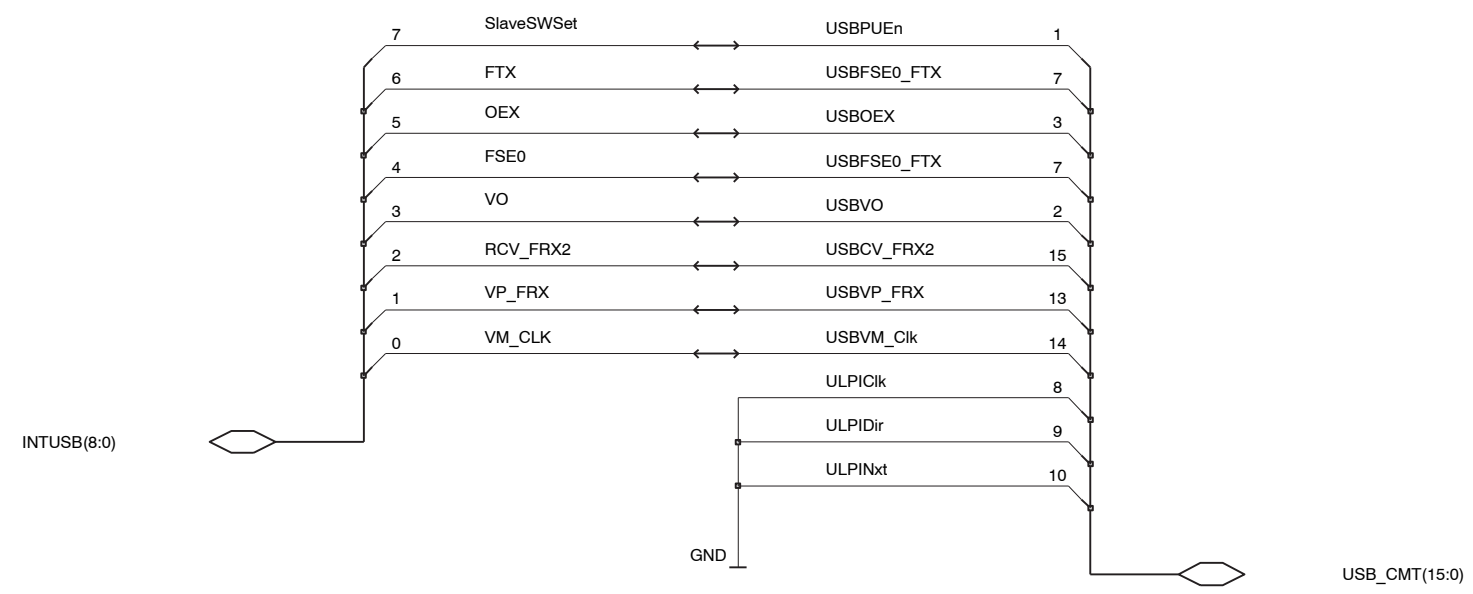

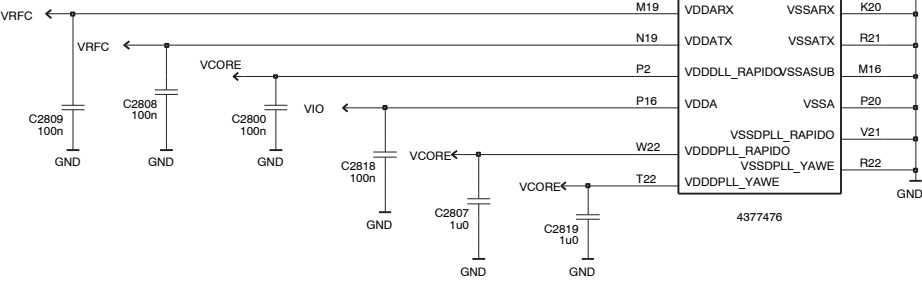
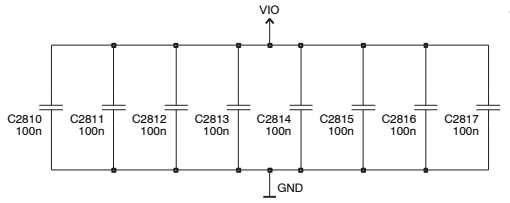
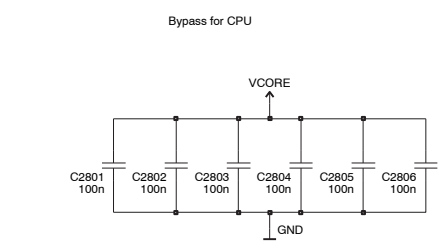
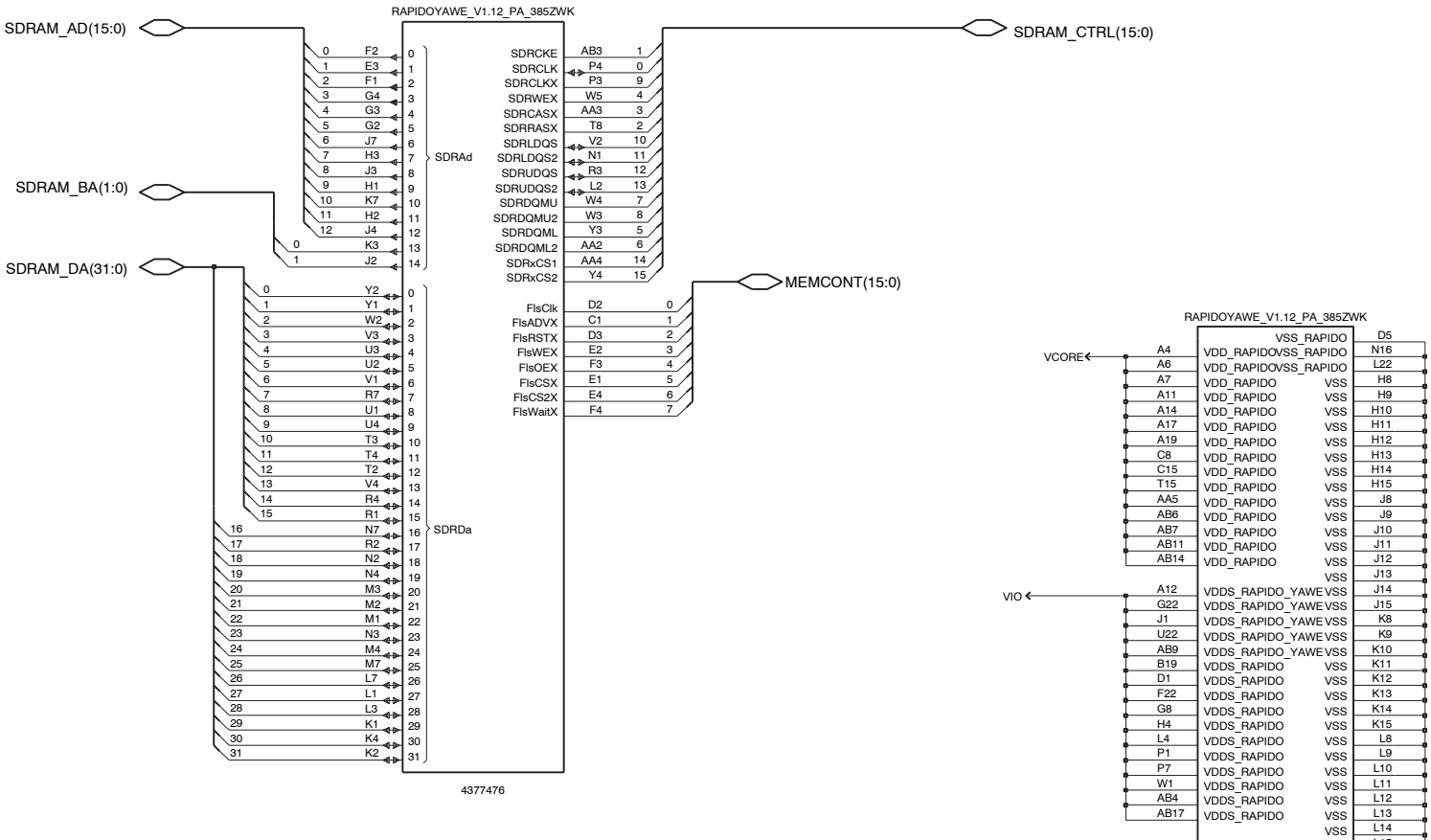
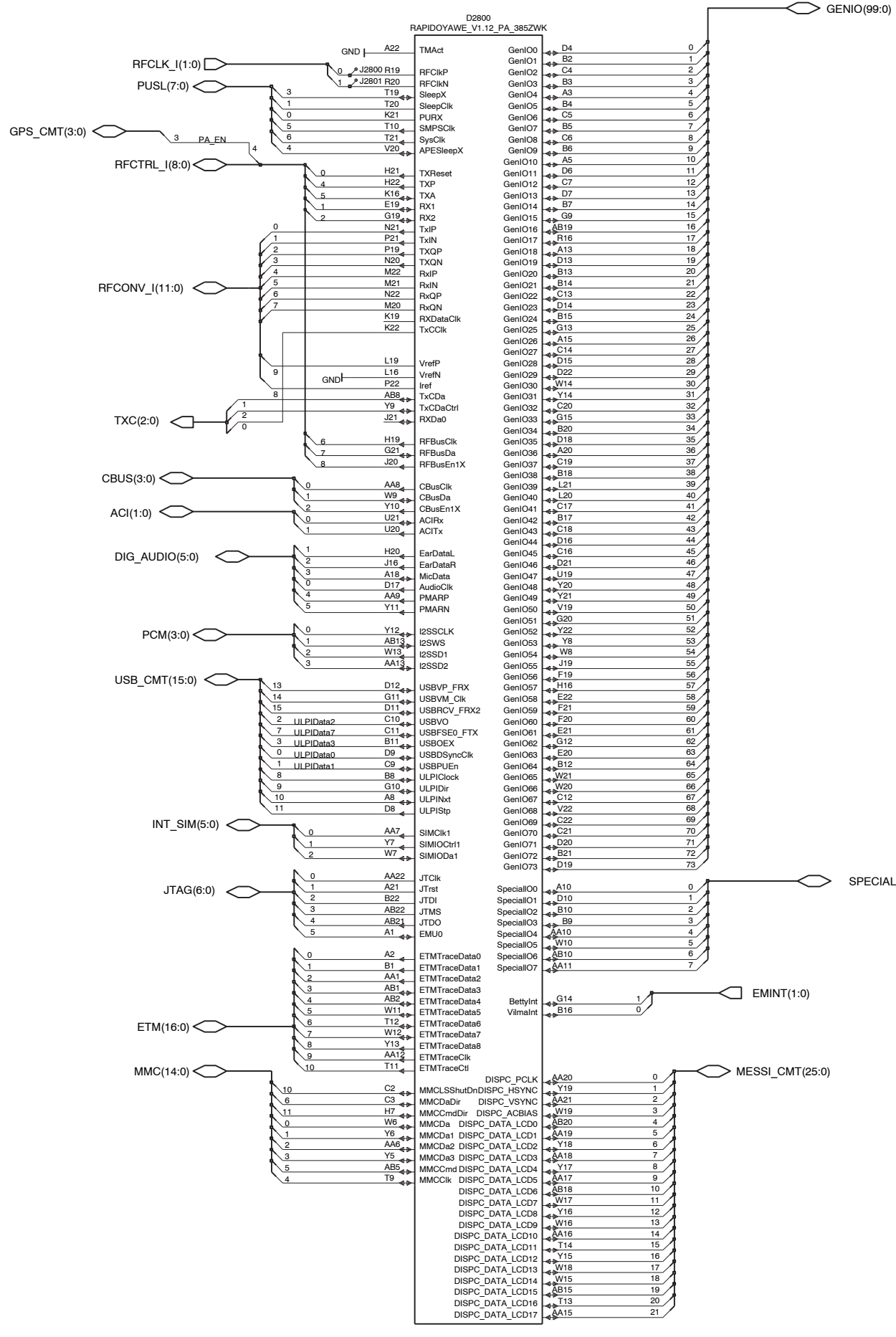

0	genio0	MEMADDA0
1	genio1	MEMADDA1
2	genio2	MEMADDA2
3	genio3	MEMADDA3
4	genio4	MEMADDA4
5	genio5	MEMADDA5
6	genio6	MEMADDA6
7	genio7	MEMADDA7
8	genio8	MEMADDA8
9	genio9	MEMADDA9
10	genio10	MEMADDA10
11	genio11	MEMADDA11
12	genio12	MEMADDA12
13	genio13	MEMADDA13
14	genio14	MEMADDA14
15	genio15	MEMADDA15
16	genio16	(Not in use)
17	genio17	Plug_det
18	genio18	Audio_PA_EN
19	genio19	Audio_data_CTRL
20	genio20	FM_Int
21	genio21	BT_Wake_up
22	genio22	FlashINT
23	genio23	Mail_LED_DR_EN
24	genio24	MMCDor
25	genio25	(Not in use)
26	genio26	(Not in use)
27	genio27	LDO_STBY
28	genio28	CAM_VCTRL
29	genio29	WLAN_IRQ
30	genio30	I2C_SDA
31	genio31	I2C_SCL
32	genio32	KEYB ROW0
33	genio33	KEYB ROW1
34	genio34	KEYB ROW2
35	genio35	KEYB ROW3
36	genio36	KEYB ROW4
37	genio37	KEYB COL0
38	genio38	KEYB COL1
39	genio39	KEYB COL2
40	genio40	KEYB COL3
41	genio41	KEYB COL4
42	genio42	DMIC_Data
43	genio43	WLAN_SPI_DIN
44	genio44	RESX
45	genio45	MMCDet
46	genio46	MMCDaDir1
47	genio47	KEYB COL5
48	genio48	I2C_ISA_SDA
49	genio49	LDO_EN
50	genio50	BT_UART_Wake
51	genio51	I2C_ISA_SCL
52	genio52	(Not in use - not allowed to use)
53	genio53	(Not in use)
54	genio54	WLAN_RESETX
55	genio55	keyb_light_en
56	genio56	IRRX
57	genio57	IRTX
58	genio58	IRSD
59	genio59	BTDAIN
60	genio60	BTDAOUT
61	genio61	(Not in use)
62	genio62	(Not in use)
63	genio63	WLAN_SPI_DOUT
64	genio64	(Not in use)
65	genio65	BTRSTX
66	genio66	STV_PDN
67	genio67	(Not in use)
68	genio68	CAMCLK
69	genio69	BTCTS
70	genio70	BTRTS
71	genio71	MMCFbClk
72	genio72	WLAN_SPI_CLK
73	genio73	WLAN_SPI_CSX

GENIO(99:0)

SPECIAL_IO(7:0)

0	specialio0	CCPDaP
1	specialio1	CCPDaN
2	specialio2	CCPClkP
3	specialio3	CCPClkN
4	specialio4	SPI_CLK
5	specialio5	SPI_CS
6	specialio6	SPI_OUT
7	specialio7	SPI_IN

PUSL(7:0)

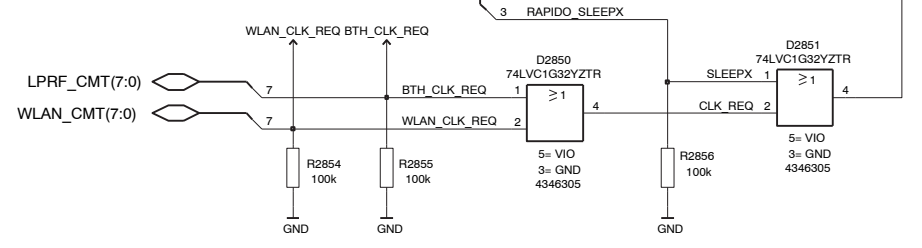

SMART SLEEP

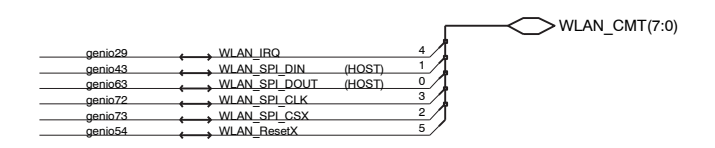
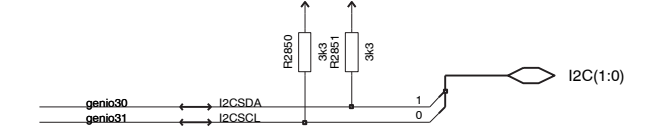
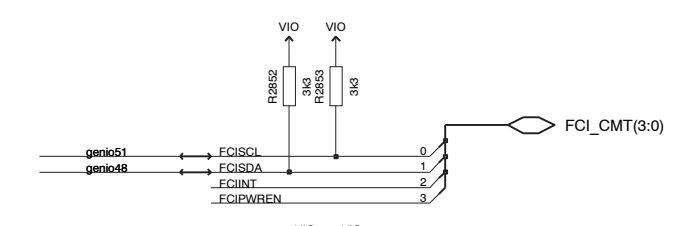
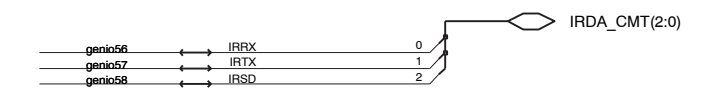
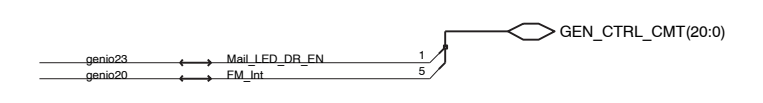
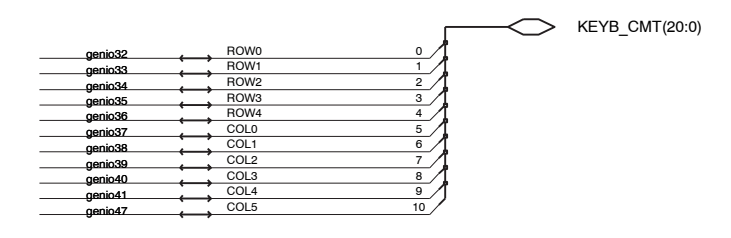
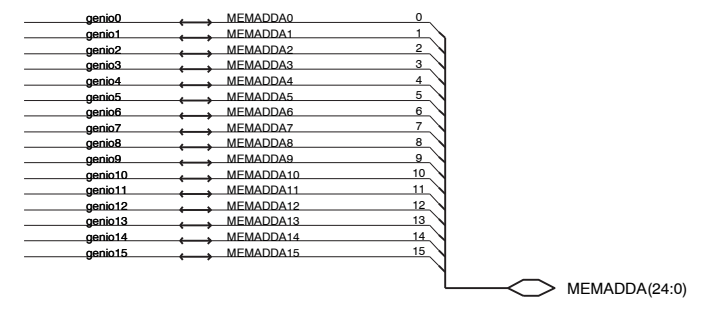
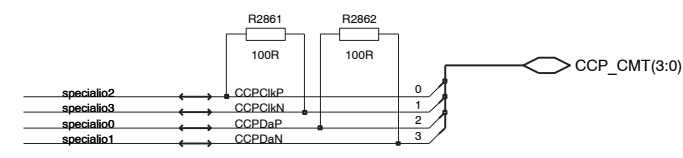
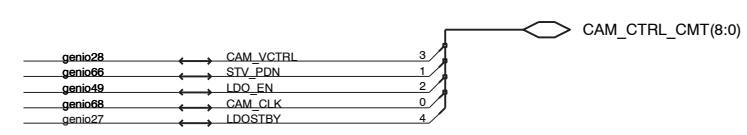
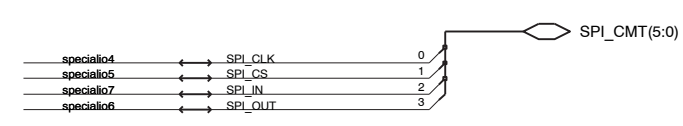
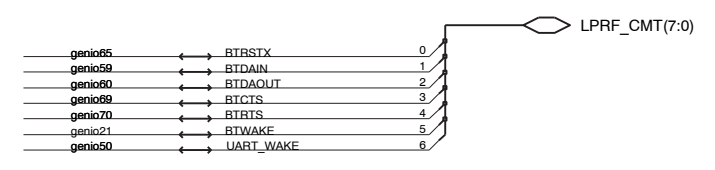
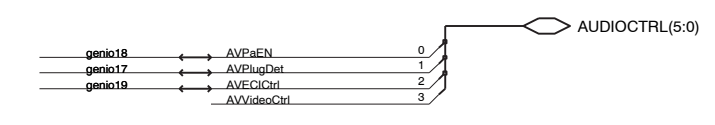
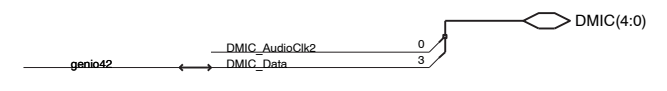

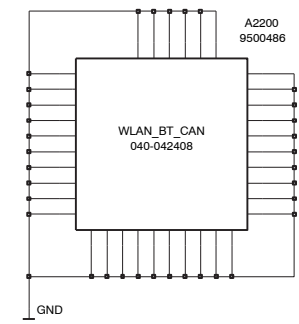
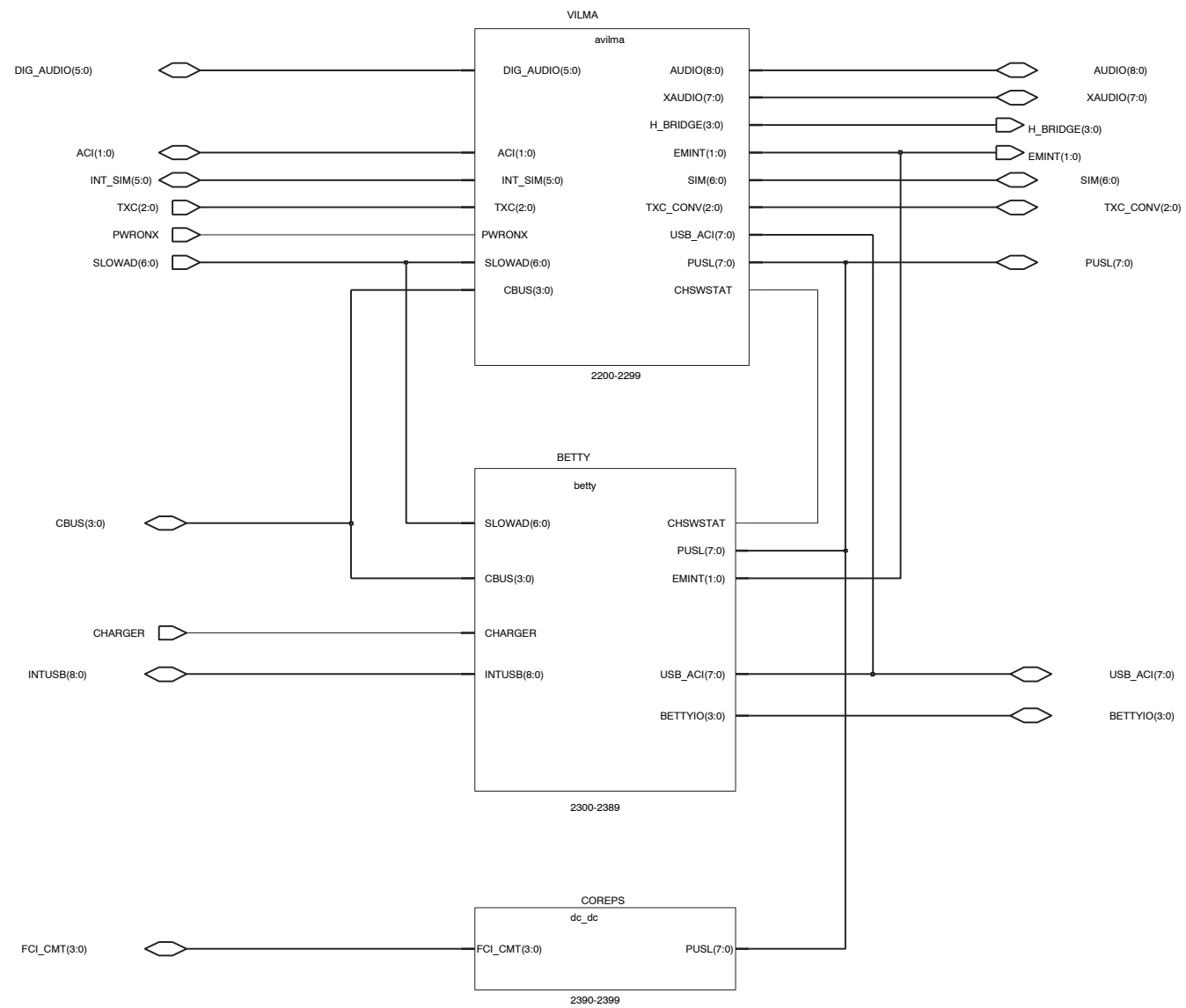

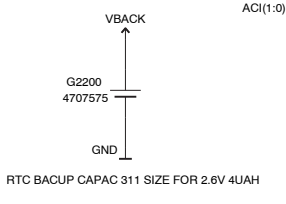
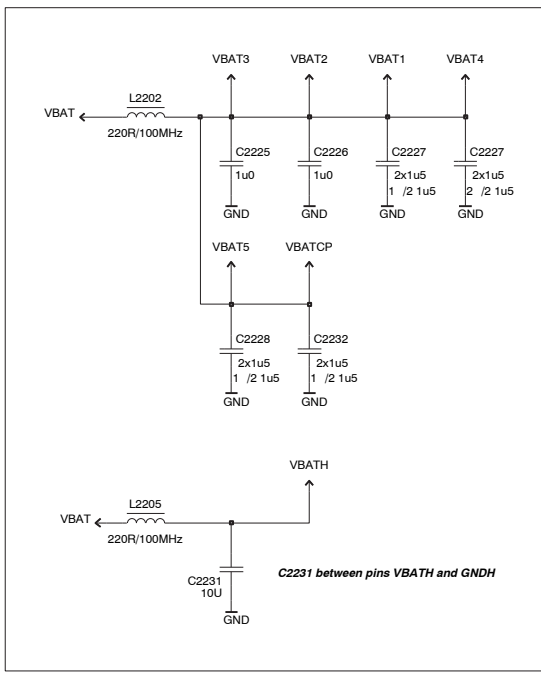
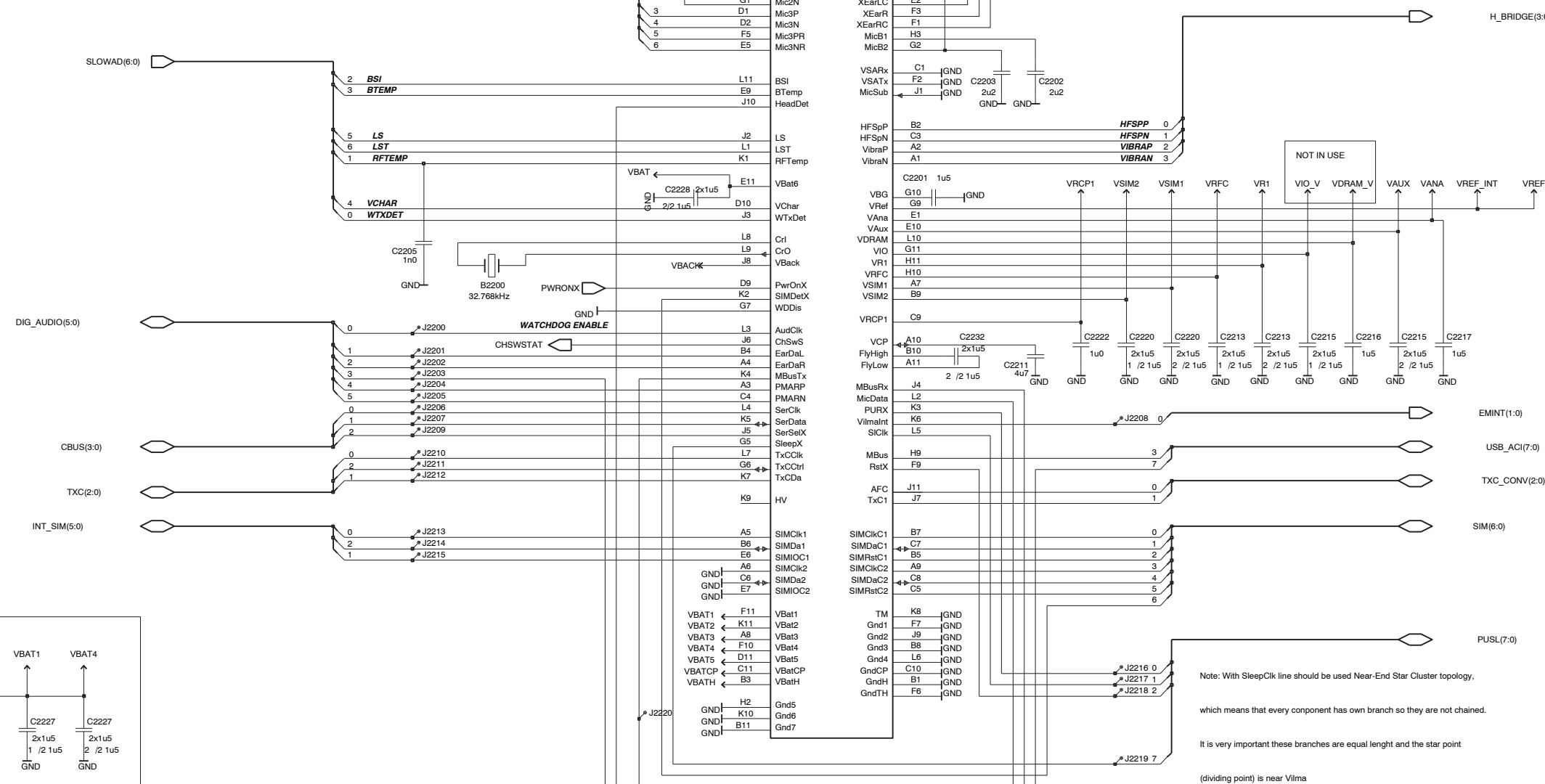
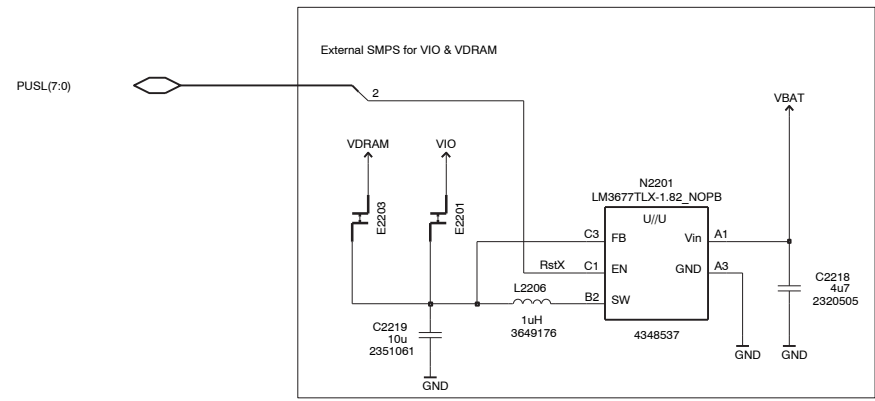

Note: With SleepClk line should be used Near-End Star Cluster topology, which means that every component has own branch so they are not chained. It is very important these branches are equal length and the star point (dividing point) is near Vilma

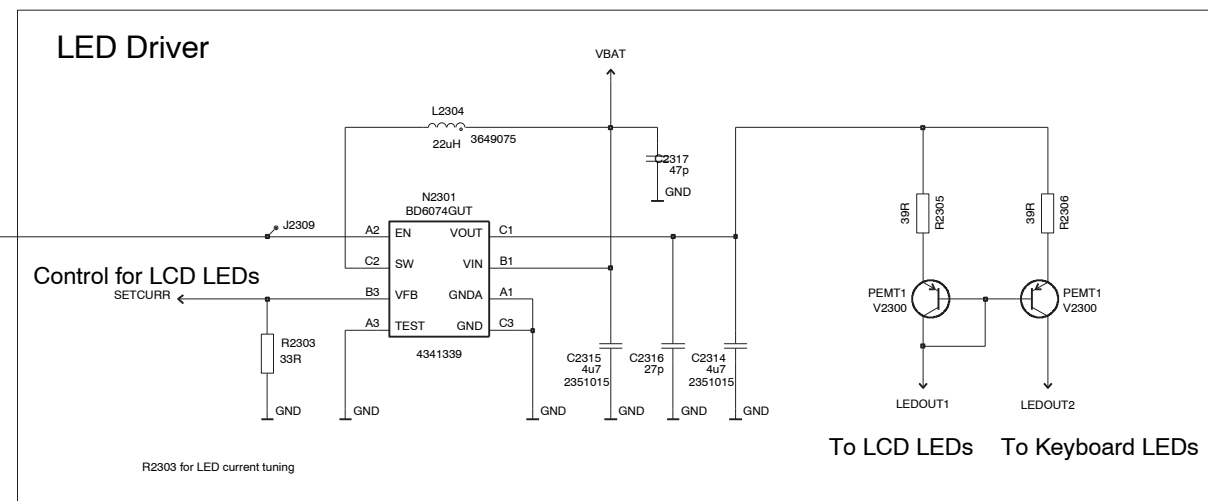
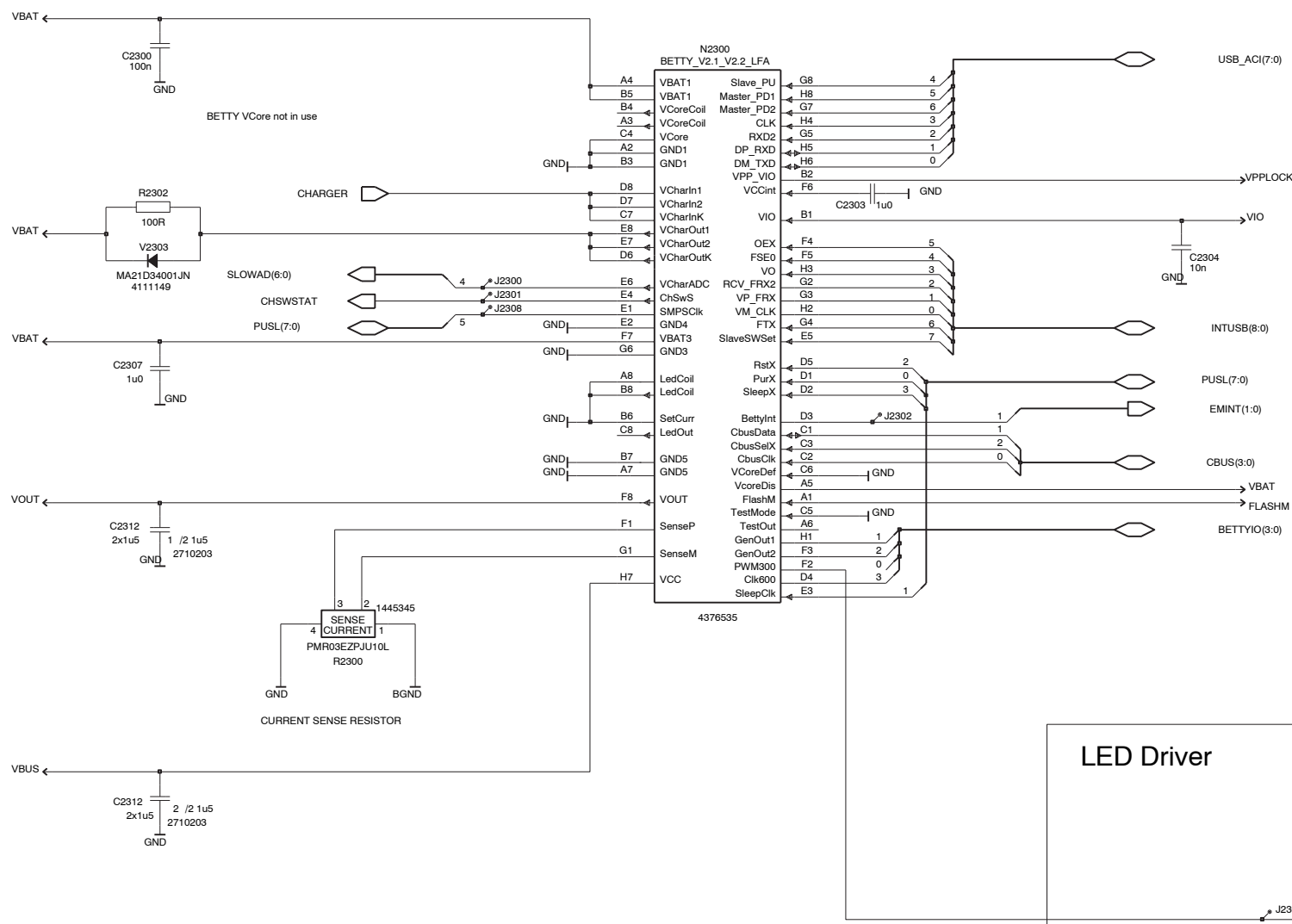

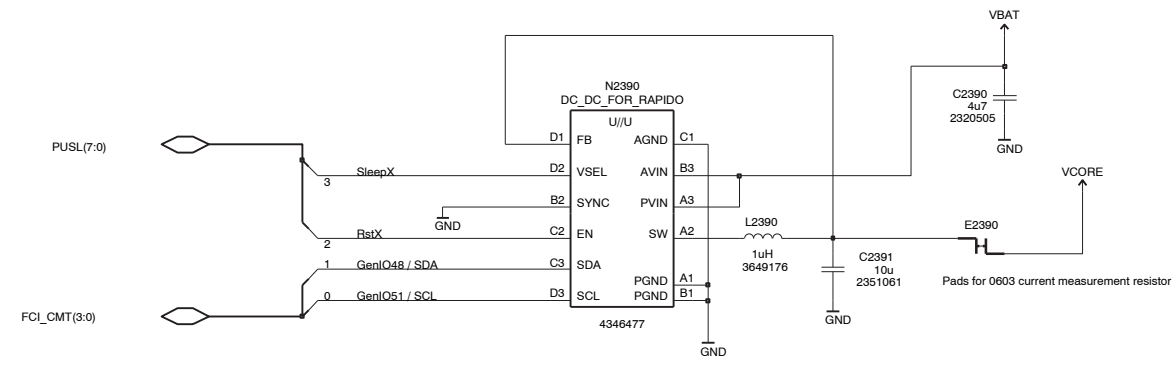

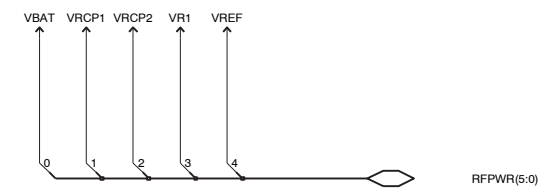
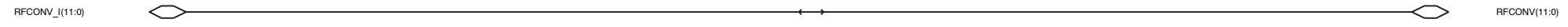
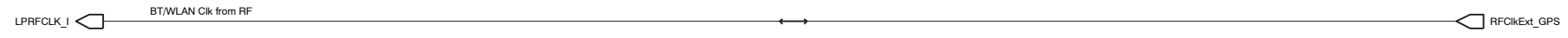
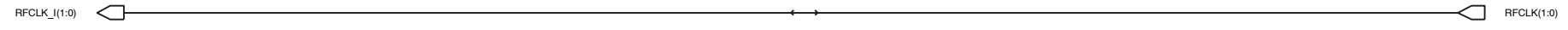

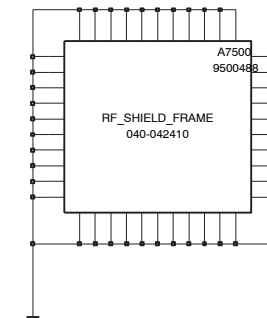
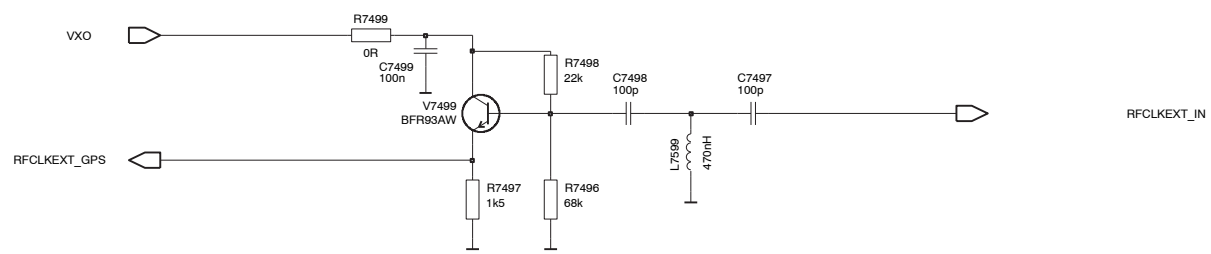
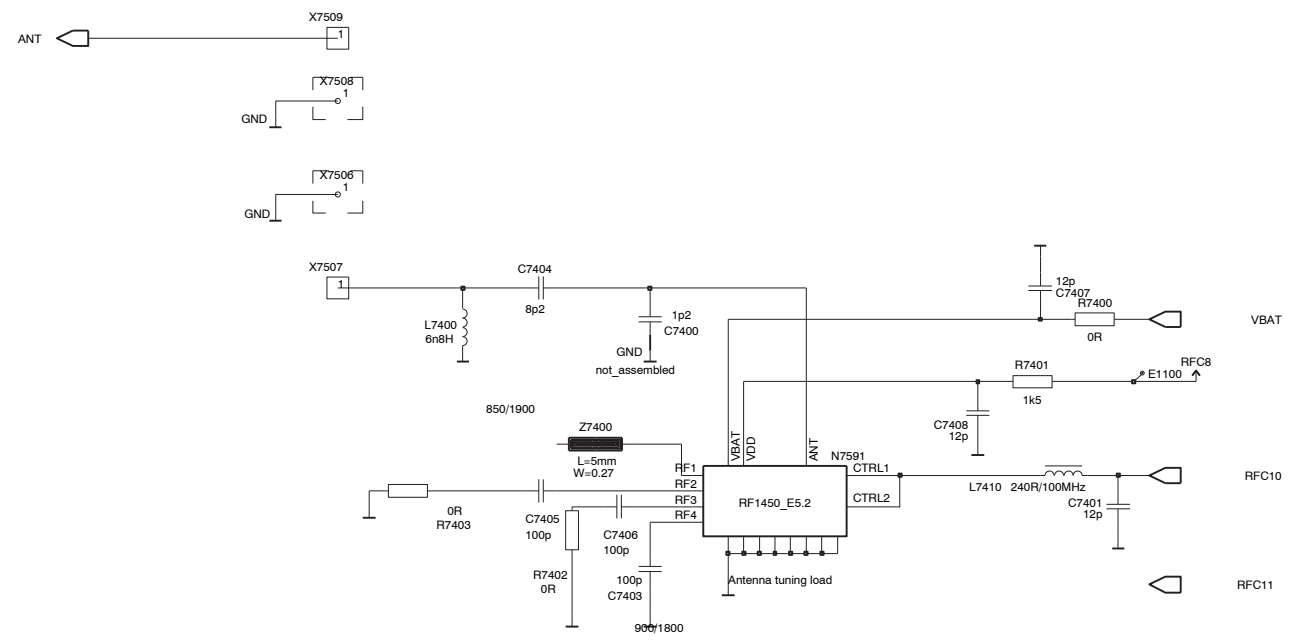

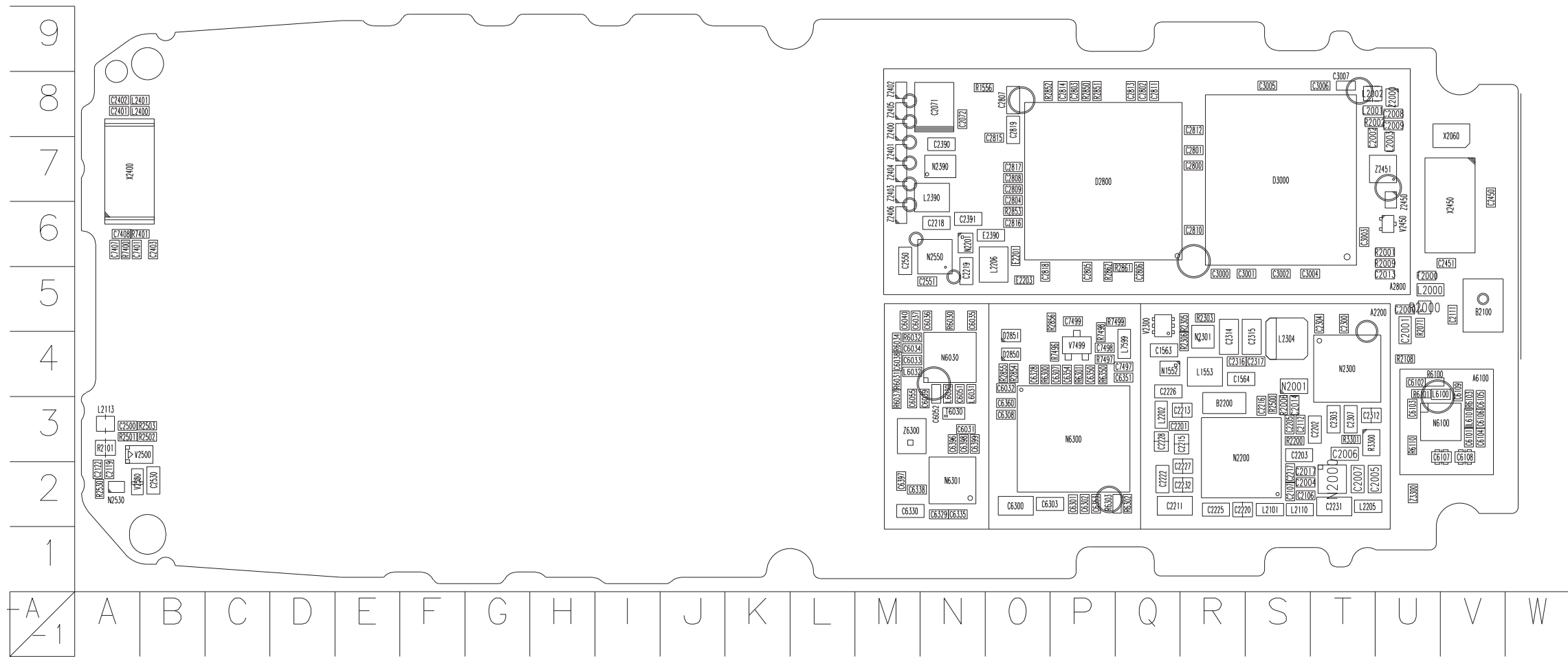

2av_06a_asmdrw_t.pdf

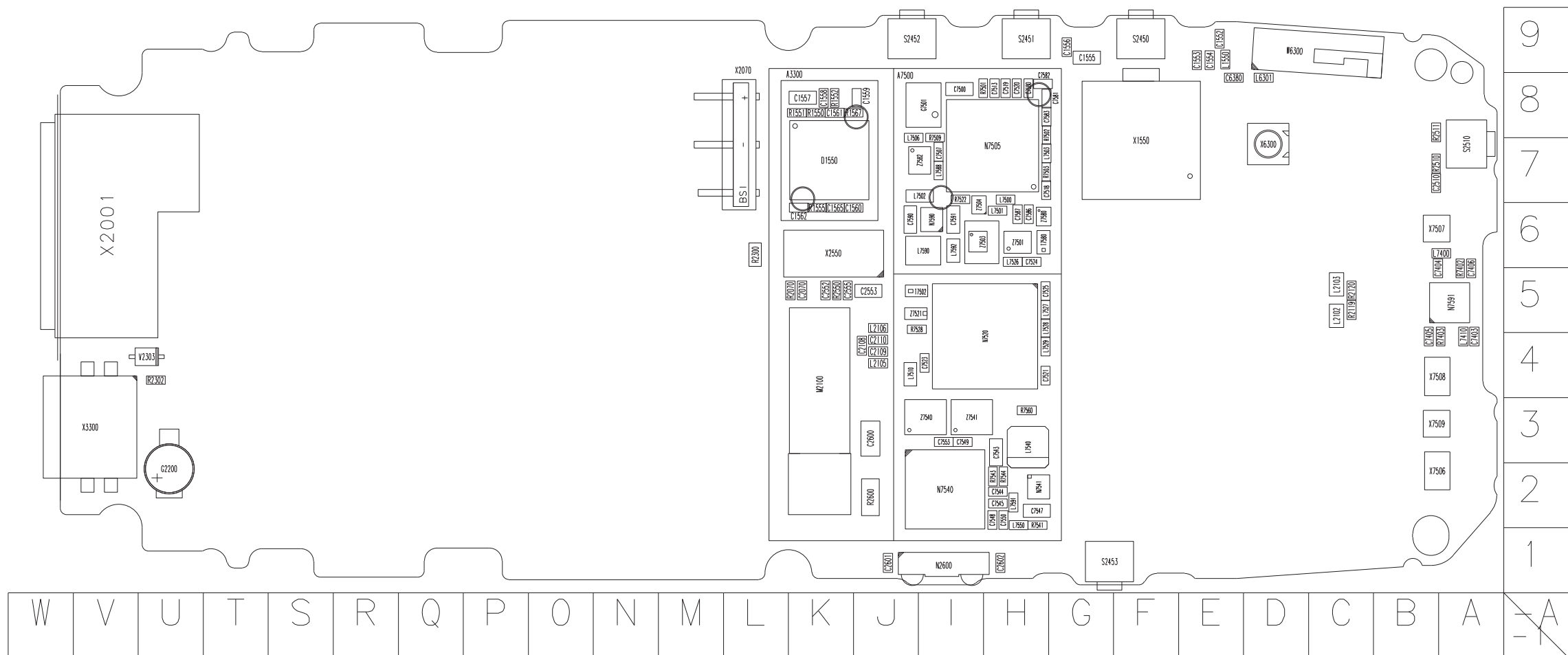

2av_06a_asmdrw_b.pdf

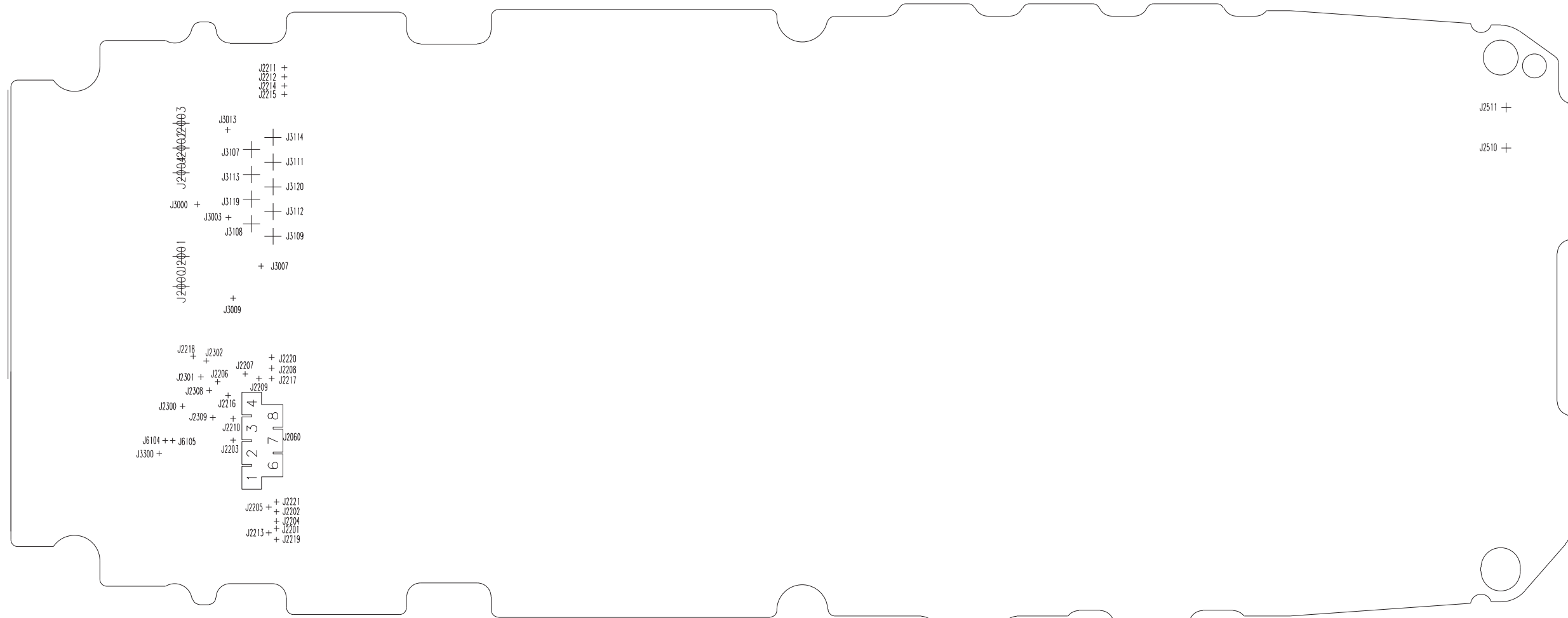

2av_06a_tstdrw_b.pdf

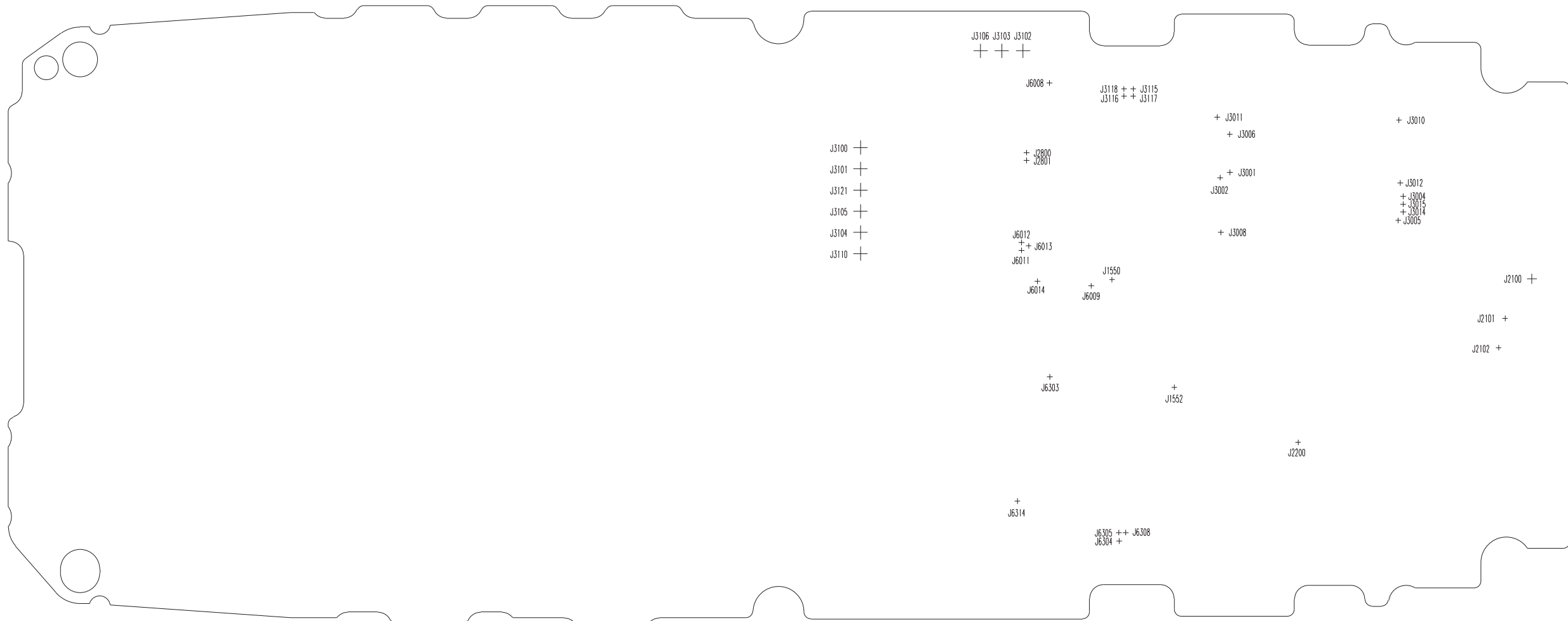

2av_06a_tstdrw_t.pdf